



UNITED AUTOMATION INC.

1491 North Kealy, Suite 4, Lewisville, TX 75057 ~ Ph (972) 420-1123 ~ Fax (972) 420-1103
PLEASE VISIT OUR WEB SITE AT: www.automation-dfw.com

TABLE OF CONTENTS

<i>One Touch Fittings</i>	4
<i>Compact One Touch Fittings</i>	14
<i>Metallic Fittings</i>	17
<i>Water Fittings</i>	21
<i>Speed Controllers</i>	24
<i>Rotary Joints..</i>	26
<i>Stop Fittings</i>	28
<i>Ball Valves</i>	29
<i>Check Valves</i>	30
<i>Hand Valves</i>	31
<i>Breather Vents and Mufflers</i>	33
<i>Tubing</i>	34
<i>Air Guns</i>	34



SPC is a registered trade name for Sang-A Pneumatic Co., Ltd. in North America. The SPC brand logo represents products that are specified in the inch system. Both Sang-A and SPC logos are the registered trade marks Co Sang-A Pneumatic Co., Ltd.



Sang-A is a registered trade name for Sang-A Pneumatic Co., Ltd. in Europe and Asia. The Sang-A brand logo represents products that are specified in the Metric system.



ONE TOUCH FITTINGS

Application:

- One-touch fittings used for pneumatic piping
- Wide variety of models available to meet all needs

Features:

- Elliptical sleeve allows easy connect/disconnect by one touch
- Straight fitting type useful for piping in confined space by fastening through internal hex
- Fittings include NBR O-ring and Teflon treated threads

STRUCTURAL DIAGRAM

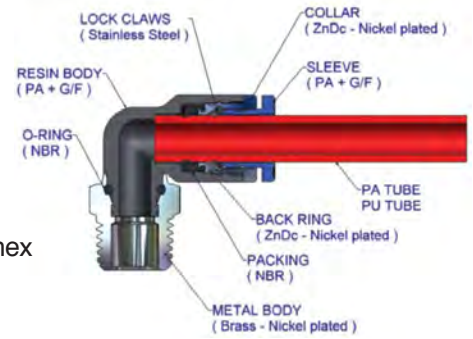

ONE TOUCH FITTINGS

PRODUCT CODE SYSTEM

PC	1/4	-	N02	U	EPNI
1	2		3	4	5

(1) Type

(2) Tube Diameter (ØD)

Inch Size		Metric Size	
Code	Dia	Code	Dia
5/32	5/32"	03	3 mm
3/16	3/16"	04	4 mm
1/4	1/4"	06	6 mm
5/16	5/16"	08	8 mm
3/8	3/8"	10	10 mm
1/2	1/2"	12	12 mm
		14	14 mm
		16	16 mm

(3) Thread Sizes (R)

Tapered Thread		Parallel Thread	
Code	Thread	Code	Thread
N1/16	N1/16" NPT	G01	G1/8" BSPP
N01	N1/8" NPT	G02	G1/4" BSPP
N02	N1/4" NPT	G03	G3/8" BSPP
N03	N3/8" NPT	G04	G1/2" BSPP
N04	N1/2" NPT	U10U	10-32 UNF
01	R1/8" BSPT	M3	M3 x 0.5
02	R1/4" BSPT	M5	M5 x 0.8
03	R3/8" BSPT	M6	M6 x 1.0
04	R1/2" BSPT		

(4) Hexagon Specification

U = Flat-to-flat Inch specification (NPT)
No code = Flat-to-flat Metric specification

(5) Features

Code	Feature
C	Compact Fitting
O	Meter Out Flow Direction
I	Meter In Flow Direction
EPNI	Electro Plated Nickel

*All fittings with metal bodies are nickel plated including part #1's that may not include EPNI

Specifications	
Fluid	AIR (No other gases or liquids)
Working Pressure Range	0 ~ 284 psi 0 ~ 1958 kPa
Negative Pressure	-14.5 psi -100 kPa
Temperature Range	32 ~ 176F 0 ~ 80C
Applicable Tubing	Polyurethane and Nylon

Case In Use

► POC/PCC Models
Hexagonal wrench must be used inside of body to fasten fitting due to round exterior

► PLPT Models
Elbow and Tee fittings allow for swivel adjustment to desired position after fastening base

Model (ØD-R)

	ØD (Inch) - R (NPT)	Bag Qty	ØD (Inch) - R (BSPT)	Bag Qty	ØD (Metric) - R (BSPT)	Bag Qty	ØD (Metric) - R (BSPP)	Bag Qty
PC MALE STRAIGHT 	PC 5/32-N01U EPNI	10	PC 5/32-R01 EPNI	10	GPC 0401 EPNI	10	GPC 04G01 EPNI	10
	PC 5/32-N02U EPNI	10	PC 5/32-R02 EPNI	10	GPC 0402 EPNI	10	GPC 04G02 EPNI	10
	PC 5/32-N03U EPNI	10	PC 5/32-R03 EPNI	10	GPC 0403 EPNI	10	GPC 04G03 EPNI	10
	PC 5/32-U10U EPNI	10	PC 3/16-R01 EPNI	10	GPC 04M5 EPNI	10	GPC 06G01 EPNI	10
	PC 3/16-N01U EPNI	10	PC 3/16-R02 EPNI	10	GPC 04M6 EPNI	10	GPC 06G02 EPNI	10
	PC 3/16-N02U EPNI	10	PC 3/16-R03 EPNI	10	GPC 0601 EPNI	10	GPC 06G03 EPNI	10
	PC 3/16-N03U EPNI	10	PC 1/4-R01 EPNI	10	GPC 0602 EPNI	10	GPC 06G04 EPNI	10
	PC 3/16-U10U EPNI	10	PC 1/4-R02 EPNI	10	GPC 0603 EPNI	10	GPC 08G01 EPNI	10
	PC 1/4-N01U EPNI	10	PC 1/4-R03 EPNI	10	GPC 0604 EPNI	10	GPC 08G02 EPNI	10
	PC 1/4-N02U EPNI	10	PC 1/4-R04 EPNI	10	GPC 06M5 EPNI	10	GPC 08G03 EPNI	10
	PC 1/4-N03U EPNI	10	PC 5/16-R01 EPNI	10	GPC 06M6 EPNI	10	GPC 08G04 EPNI	10
	PC 1/4-N04U EPNI	10	PC 5/16-R02 EPNI	10	GPC 0801 EPNI	10	GPC 10G01 EPNI	10
	PC 1/4-U10U EPNI	10	PC 5/16-R03 EPNI	10	GPC 0802 EPNI	10	GPC 10G02 EPNI	10
	PC 5/16-N01U EPNI	10	PC 5/16-R04 EPNI	10	GPC 0803 EPNI	10	GPC 10G03 EPNI	10
	PC 5/16-N02U EPNI	10	PC 3/8-R01 EPNI	10	GPC 0804 EPNI	10	GPC 10G04 EPNI	10
	PC 5/16-N03U EPNI	10	PC 3/8-R02 EPNI	10	GPC 1001 EPNI	10	GPC 12G01 EPNI	10
	PC 5/16-N04U EPNI	10	PC 3/8-R03 EPNI	10	GPC 1002 EPNI	10	GPC 12G02 EPNI	10
	PC 3/8-N01U EPNI	10	PC 3/8-R04 EPNI	10	GPC 1003 EPNI	10	GPC 12G03 EPNI	10
	PC 3/8-N02U EPNI	10	PC 1/2-R01 EPNI	10	GPC 1004 EPNI	10	GPC 12G04 EPNI	5
	PC 3/8-N03U EPNI	10	PC 1/2-R02 EPNI	10	GPC 1201 EPNI	10	GPC 14G03 EPNI	5
	PC 3/8-N04U EPNI	10	PC 1/2-R03 EPNI	10	GPC 1202 EPNI	10	GPC 14G04 EPNI	5
	PC 1/2-N01U EPNI	10	PC 1/2-R04 EPNI	5	GPC 1203 EPNI	10	GPC 16G03 EPNI	5
	PC 1/2-N02U EPNI	10			GPC 1204 EPNI	5	GPC 16G04 EPNI	5
	PC 1/2-N03U EPNI	10			GPC 1403 EPNI	5		
	PC 1/2-N04U EPNI	5			GPC 1404 EPNI	5		
					GPC 1603 EPNI	5		
					GPC 1604 EPNI	5		

Model (ØD-R)

	ØD (Inch) - R (NPT)	Bag Qty	ØD (Inch) - R (BSPT)	Bag Qty	ØD (Metric) - R (BSPT)	Bag Qty	ØD (Metric) - R (BSPP)	Bag Qty
POC ROUND MALE STRAIGHT 	POC 5/32-N01U EPNI	10	POC 1/4-R01 EPNI	10	GPOC 0401 EPNI	10	GPOC 04G01 EPNI	10
	POC 5/32-N02U EPNI	10	POC 1/4-R02 EPNI	10	GPOC 0402 EPNI	10	GPOC 04G02 EPNI	10
	POC 5/32-N03U EPNI	10	POC 5/16-R01 EPNI	10	GPOC 0403 EPNI	10	GPOC 04G03 EPNI	10
	POC 5/32-U10U EPNI	10	POC 5/16-R02 EPNI	10	GPOC 04M5 EPNI	10	GPOC 06G01 EPNI	10
	POC 3/16-N01 EPNI	10	POC 5/16-R03 EPNI	10	GPOC 04M6 EPNI	10	GPOC 06G02 EPNI	10
	POC 3/16-N02 EPNI	10	POC 3/8-R02 EPNI	10	GPOC 0601 EPNI	10	GPOC 06G03 EPNI	10
	POC 3/16-U10U EPNI	10	POC 3/8-R03 EPNI	10	GPOC 0602 EPNI	10	GPOC 08G01 EPNI	10
	POC 1/4-N01U EPNI	10	POC 3/8-R04 EPNI	10	GPOC 0603 EPNI	10	GPOC 08G02 EPNI	10
	POC 1/4-N02U EPNI	10			GPOC 06M5 EPNI	10	GPOC 08G03 EPNI	10
	POC 1/4-U10U EPNI	10			GPOC 06M6 EPNI	10	GPOC 08G04 EPNI	10
	POC 5/16-N01U EPNI	10			GPOC 0801 EPNI	10	GPOC 10G01 EPNI	10
	POC 5/16-N02U EPNI	10			GPOC 0802 EPNI	10	GPOC 10G02 EPNI	10
	POC 5/16-N03U EPNI	10			GPOC 0803 EPNI	10	GPOC 10G03 EPNI	10
	POC 5/16-N04U EPNI	10			GPOC 0804 EPNI	10	GPOC 10G04 EPNI	10
	POC 3/8-N01U EPNI	10			GPOC 1001 EPNI	10	GPOC 12G01 EPNI	10
	POC 3/8-N02U EPNI	10			GPOC 1002 EPNI	10	GPOC 12G02 EPNI	10
	POC 3/8-N03U EPNI	10			GPOC 1003 EPNI	10	GPOC 12G03 EPNI	10
	POC 3/8-N04U EPNI	10			GPOC 1004 EPNI	10	GPOC 12G04 EPNI	5
	POC 1/2-N02U EPNI	10			GPOC 1201 EPNI	10		
	POC 1/2-N03U EPNI	10			GPOC 1202 EPNI	10		
	POC 1/2-N04U EPNI	5			GPOC 1203 EPNI	10		
					GPOC 1204 EPNI	5		

Model (ØD-R)

	ØD (Inch) - R (NPT) Bag Qty	ØD (Inch) - R (BSPT) Bag Qty	ØD (Metric) - R (BSPT) Bag Qty	ØD (Metric) - R (BSPP) Bag Qty
PCF FEMALE STRAIGHT 	PCF 5/32-N01U EPNI10	PCF 5/32-Rc01 EPNI10	GPCF 0401 EPNI10	GPCF 04G01 EPNI10
	PCF 5/32-N02U EPNI10	PCF 5/32-Rc02 EPNI10	GPCF 0402 EPNI10	GPCF 04G02 EPNI10
	PCF 3/16-N01U EPNI10	PCF 5/32-Rc03 EPNI10	GPCF 0403 EPNI10	GPCF 04G03 EPNI10
	PCF 3/16-N02U EPNI10	PCF 3/16-Rc01 EPNI10	GPCF 0601 EPNI10	GPCF 06G01 EPNI10
	PCF 1/4-N01U EPNI10	PCF 3/16-Rc02 EPNI10	GPCF 0602 EPNI10	GPCF 06G02 EPNI10
	PCF 1/4-N02U EPNI10	PCF 1/4-Rc01 EPNI10	GPCF 0603 EPNI10	GPCF 06G03 EPNI10
	PCF 1/4-N03U EPNI10	PCF 1/4-Rc02 EPNI10	GPCF 0801 EPNI10	GPCF 08G01 EPNI10
	PCF 5/16-N01U EPNI10	PCF 1/4-Rc03 EPNI10	GPCF 0802 EPNI10	GPCF 08G02 EPNI10
	PCF 5/16-N02U EPNI10	PCF 5/16-Rc01 EPNI10	GPCF 0803 EPNI10	GPCF 08G03 EPNI10
	PCF 5/16-N03U EPNI10	PCF 5/16-Rc02 EPNI10	GPCF 0804 EPNI5	GPCF 08G04 EPNI5
	PCF 5/16-N04U EPNI5	PCF 5/16-Rc03 EPNI10	GPCF 1001 EPNI10	GPCF 10G01 EPNI10
	PCF 3/8-N01U EPNI10	PCF 5/16-Rc04 EPNI5	GPCF 1002 EPNI10	GPCF 10G02 EPNI10
	PCF 3/8-N02U EPNI10	PCF 3/8-Rc01 EPNI10	GPCF 1003 EPNI5	GPCF 10G03 EPNI5
	PCF 3/8-N03U EPNI5	PCF 3/8-Rc02 EPNI10	GPCF 1004 EPNI5	GPCF 10G04 EPNI5
	PCF 3/8-N04U EPNI5	PCF 3/8-Rc03 EPNI5	GPCF 1202 EPNI5	GPCF 12G02 EPNI5
	PCF 1/2-N02U EPNI5	PCF 3/8-Rc04 EPNI5	GPCF 1203 EPNI5	GPCF 12G03 EPNI5
	PCF 1/2-N03U EPNI5	PCF 1/2-Rc02 EPNI5	GPCF 1204 EPNI5	GPCF 12G04 EPNI5
	PCF 1/2-N04U EPNI5	PCF 1/2-Rc03 EPNI5	GPCF 1604 EPNI3	GPCF 16G04 EPNI3
		PCF 1/2-Rc04 EPNI5		

Model (ØD-R)

	ØD (Inch) - R (NPT) Bag Qty	ØD (Inch) - R (BSPT) Bag Qty	ØD (Metric) - R (BSPT) Bag Qty	ØD (Metric) - R (BSPP) Bag Qty
PL MALE ELBOW 	PL 5/32-N01U EPNI10	PL 5/32-R01 EPNI10	GPL 0401 EPNI10	GPL 04G01 EPNI10
	PL 5/32-N02U EPNI10	PL 5/32-R02 EPNI10	GPL 0402 EPNI10	GPL 04G02 EPNI10
	PL 5/32-N03U EPNI10	PL 5/32-R03 EPNI10	GPL 0403 EPNI10	GPL 04G03 EPNI10
	PL 5/32-U10U EPNI10	PL 3/16-R01 EPNI10	GPL 04M5 EPNI10	GPL 06G01 EPNI10
	PL 3/16-N01U EPNI10	PL 3/16-R02 EPNI10	GPL 04M6 EPNI10	GPL 06G02 EPNI10
	PL 3/16-N02U EPNI10	PL 3/16-R03 EPNI10	GPL 0601 EPNI10	GPL 06G03 EPNI10
	PL 3/16-N03U EPNI10	PL 1/4-R01 EPNI10	GPL 0602 EPNI10	GPL 06G04 EPNI5
	PL 3/16-U10U EPNI10	PL 1/4-R02 EPNI10	GPL 0603 EPNI10	GPL 08G01 EPNI10
	PL 1/4-N01U EPNI10	PL 1/4-R03 EPNI10	GPL 0604 EPNI5	GPL 08G02 EPNI10
	PL 1/4-N02U EPNI10	PL 1/4-R04 EPNI10	GPL 06M5 EPNI10	GPL 08G03 EPNI10
	PL 1/4-N03U EPNI10	PL 5/16-R01 EPNI10	GPL 06M6 EPNI10	GPL 08G04 EPNI5
	PL 1/4-N04U EPNI10	PL 5/16-R02 EPNI10	GPL 0801 EPNI10	GPL 10G01 EPNI10
	PL 1/4-U10U EPNI10	PL 5/16-R03 EPNI10	GPL 0802 EPNI10	GPL 10G02 EPNI5
	PL 5/16-N01U EPNI10	PL 5/16-R04 EPNI5	GPL 0803 EPNI10	GPL 10G03 EPNI5
	PL 5/16-N02U EPNI10	PL 3/8-R01 EPNI10	GPL 0804 EPNI5	GPL 10G04 EPNI5
	PL 5/16-N03U EPNI10	PL 3/8-R02 EPNI5	GPL 1001 EPNI10	GPL 12G01 EPNI5
	PL 5/16-N04U EPNI5	PL 3/8-R03 EPNI5	GPL 1002 EPNI5	GPL 12G02 EPNI5
	PL 3/8-N01U EPNI10	PL 3/8-R04 EPNI5	GPL 1003 EPNI5	GPL 12G03 EPNI5
	PL 3/8-N02U EPNI5	PL 1/2-R01 EPNI5	GPL 1004 EPNI5	GPL 12G04 EPNI5
	PL 3/8-N03U EPNI5	PL 1/2-R02 EPNI5	GPL 1201 EPNI5	GPL 14G03 EPNI5
PL 3/8-N04U EPNI5	PL 1/2-R03 EPNI5	GPL 1202 EPNI5	GPL 14G04 EPNI5	
PL 1/2-N01U EPNI5	PL 1/2-R04 EPNI5	GPL 1203 EPNI5	GPL 16G03 EPNI5	
PL 1/2-N02U EPNI5		GPL 1204 EPNI5	GPL 16G04 EPNI5	
PL 1/2-N03U EPNI5		GPL 1403 EPNI5		
PL 1/2-N04U EPNI5		GPL 1404 EPNI5		
		GPL 1603 EPNI5		
		GPL 1604 EPNI5		

Model (ØD-R)

	ØD (Inch) - R (NPT) Bag Qty	ØD (Inch) - R (BSPT) Bag Qty	ØD (Metric) - R (BSPT) Bag Qty	ØD (Metric) - R (BSPP) Bag Qty
PL45 MALE 45 ELBOW 	PL45 5/32-N01U EPNI10	PL45 5/32-01 EPNI10	GPL45 0401 EPNI10	GPL45 04G01 EPNI10
	PL45 5/32-N02U EPNI10	PL45 5/32-02 EPNI10	GPL45 0402 EPNI10	GPL45 04G02 EPNI10
	PL45 5/32-N03U EPNI10	PL45 5/32-03 EPNI10	GPL45 0403 EPNI10	GPL45 04G03 EPNI10
	PL45 5/32-U10U EPNI10	PL45 5/32-M5 EPNI10	GPL45 04M5 EPNI10	GPL45 06G01 EPNI10
	PL45 3/16-N01U EPNI10	PL45 5/32-M6 EPNI10	GPL45 04M6 EPNI10	GPL45 06G02 EPNI10
	PL45 3/16-N02U EPNI10	PL45 3/16-01 EPNI10	GPL45 0601 EPNI10	GPL45 06G03 EPNI10
	PL45 3/16-N03U EPNI10	PL45 3/16-02 EPNI10	GPL45 0602 EPNI10	GPL45 06G04 EPNI10
	PL45 3/16-U10U EPNI10	PL45 3/16-03 EPNI10	GPL45 0603 EPNI10	GPL45 08G01 EPNI10
	PL45 1/4-N01U EPNI10	PL45 3/16-M5 EPNI10	GPL45 0604 EPNI10	GPL45 08G02 EPNI10
	PL45 1/4-N02U EPNI10	PL45 1/4-01 EPNI10	GPL45 06M5 EPNI10	GPL45 08G03 EPNI10
	PL45 1/4-N03U EPNI10	PL45 1/4-02 EPNI10	GPL45 06M6 EPNI10	GPL45 08G04 EPNI5
	PL45 1/4-N04U EPNI10	PL45 1/4-03 EPNI10	GPL45 0801 EPNI10	GPL45 10G01 EPNI5
	PL45 1/4-U10U EPNI10	PL45 1/4-04 EPNI10	GPL45 0802 EPNI10	GPL45 10G02 EPNI5
	PL45 5/16-N01U EPNI10	PL45 1/4-M5 EPNI10	GPL45 0803 EPNI10	GPL45 10G03 EPNI5
	PL45 5/16-N02U EPNI10	PL45 1/4-M6 EPNI10	GPL45 0804 EPNI5	GPL45 10G04 EPNI5
	PL45 5/16-N03U EPNI10	PL45 5/16-01 EPNI10	GPL45 1001 EPNI5	GPL45 12G01 EPNI5
	PL45 5/16-N04U EPNI10	PL45 5/16-02 EPNI10	GPL45 1002 EPNI5	GPL45 12G02 EPNI5
	PL45 3/8-N01U EPNI10	PL45 5/16-03 EPNI10	GPL45 1003 EPNI5	GPL45 12G03 EPNI5
	PL45 3/8-N02U EPNI10	PL45 5/16-04 EPNI5	GPL45 1004 EPNI5	GPL45 12G04 EPNI5
	PL45 3/8-N03U EPNI10	PL45 3/8-01 EPNI10	GPL45 1201 EPNI5	
PL45 3/8-N04U EPNI5	PL45 3/8-02 EPNI5	GPL45 1202 EPNI5		
PL45 1/2-N01U EPNI5	PL45 3/8-03 EPNI5	GPL45 1203 EPNI5		
PL45 1/2-N02U EPNI5	PL45 3/8-04 EPNI5	GPL45 1204 EPNI5		
PL45 1/2-N03U EPNI5	PL45 1/2-01 EPNI5			
PL45 1/2-N04U EPNI5	PL45 1/2-02 EPNI5			
	PL45 1/2-03 EPNI5			
	PL45 1/2-04 EPNI5			

Model (ØD-R)

	ØD (Inch) - R (NPT) Bag Qty	ØD (Inch) - R (BSPT) Bag Qty	ØD (Metric) - R (BSPT) Bag Qty	ØD (Metric) -R (BSPP) Bag Qty
PLL EXTENDED MALE ELBOW 	PLL 5/32-N01U EPNI10	PLL 5/32-M5 EPNI.....10	GPLL 0401 EPNI.....10	GPLL 04G01 EPNI10
	PLL 5/32-N02U EPNI10	PLL 5/32-M6 EPNI.....10	GPLL 0402 EPNI.....10	GPLL 04G02 EPNI10
	PLL 5/32-N03U EPNI10	PLL 5/32-R01 EPNI10	GPLL 0403 EPNI10	GPLL 04G03 EPNI10
	PLL 5/32-U10U EPNI10	PLL 5/32-R02 EPNI10	GPLL 04M5 EPNI10	GPLL 06G01 EPNI10
	PLL 3/16-N01U EPNI10	PLL 5/32-R03 EPNI10	GPLL 04M6 EPNI10	GPLL 06G02 EPNI10
	PLL 3/16-N02U EPNI10	PLL 3/16-R01 EPNI10	GPLL 0601 EPNI10	GPLL 06G03 EPNI10
	PLL 3/16-N03U EPNI10	PLL 3/16-R02 EPNI10	GPLL 0602 EPNI10	GPLL 06G04 EPNI5
	PLL 1/4-N01U EPNI10	PLL 3/16-R03 EPNI10	GPLL 0603 EPNI10	GPLL 08G01 EPNI10
	PLL 1/4-N02U EPNI10	PLL 3/16-M5 EPNI.....10	GPLL 06M5 EPNI10	GPLL 08G02 EPNI10
	PLL 1/4-N03U EPNI10	PLL 1/4-R01 EPNI10	GPLL 06M6 EPNI10	GPLL 08G03 EPNI5
	PLL 1/4-U10U EPNI10	PLL 1/4-R02 EPNI10	GPLL 0801 EPNI10	GPLL 08G04 EPNI5
	PLL 5/16-N01U EPNI10	PLL 1/4-R03 EPNI10	GPLL 0802 EPNI10	GPLL 10G01 EPNI5
	PLL 5/16-N02U EPNI10	PLL 1/4-M5 EPNI10	GPLL 0803 EPNI5	GPLL 10G02 EPNI5
	PLL 5/16-N03U EPNI5	PLL 1/4-M6 EPNI.....10	GPLL 0804 EPNI5	GPLL 10G03 EPNI5
	PLL 3/8-N01U EPNI5	PLL 5/16-R01 EPNI10	GPLL 1001 EPNI5	GPLL 10G04 EPNI5
	PLL 3/8-N02U EPNI5	PLL 5/16-R02 EPNI10	GPLL 1002 EPNI5	GPLL 12G01 EPNI5
	PLL 3/8-N03U EPNI5	PLL 5/16-R03 EPNI5	GPLL 1003 EPNI5	GPLL 12G02 EPNI5
	PLL 3/8-N04U EPNI5	PLL 5/16-R04 EPNI5	GPLL 1004 EPNI5	GPLL 12G03 EPNI5
	PLL 1/2-N02U EPNI5	PLL 3/8-R01 EPNI5	GPLL 1201 EPNI5	GPLL 12G04 EPNI5
	PLL 1/2-N03U EPNI5	PLL 3/8-R02 EPNI5	GPLL 1202 EPNI5	GPLL 14G03 EPNI4
	PLL 1/2-N04U EPNI5	PLL 3/8-R03 EPNI5	GPLL 1203 EPNI5	GPLL 14G04 EPNI4
		PLL 3/8-R04 EPNI5	GPLL 1204 EPNI5	GPLL 16G04 EPNI4
		PLL 1/2-R01 EPNI5	GPLL 1403 EPNI4	
		PLL 1/2-R02 EPNI5	GPLL 1404 EPNI4	
		PLL 1/2-R03 EPNI5	GPLL 1604 EPNI4	
	PLL 1/2-R04 EPNI5			

Model (ØD-R)

	ØD (Inch) - R (NPT) Bag Qty	ØD (Inch) - R (BSPT) Bag Qty	ØD (Metric) - R (BSPT) Bag Qty	ØD (Metric) -R (BSPP) Bag Qty
PLLP EXTENDED MALE ELBOW PLASTIC 	PLLP 5/32-N01U EPNI10	PLLP 5/32-01 EPNI10	GPLLP 0401 EPNI.....10	GPLLP 04G01 EPNI10
	PLLP 5/32-N02U EPNI10	PLLP 5/32-02 EPNI10	GPLLP 0402 EPNI.....10	GPLLP 04G02 EPNI10
	PLLP 5/32-N03U EPNI10	PLLP 5/32-03 EPNI10	GPLLP 0403 EPNI10	GPLLP 04G03 EPNI10
	PLLP 5/32-U10U EPNI10	PLLP 5/32-M5 EPNI10	GPLLP 04M5 EPNI10	GPLLP 06G01 EPNI10
	PLLP 1/4-N01U EPNI10	PLLP 1/4-01 EPNI10	GPLLP 04M6 EPNI10	GPLLP 06G02 EPNI10
	PLLP 1/4-N02U EPNI10	PLLP 1/4-02 EPNI10	GPLLP 0601 EPNI10	GPLLP 06G03 EPNI10
	PLLP 1/4-N03U EPNI10	PLLP 1/4-03 EPNI5	GPLLP 0602 EPNI10	GPLLP 06G04 EPNI5
	PLLP 1/4-N04U EPNI5	PLLP 1/4-04 EPNI5	GPLLP 0603 EPNI10	GPLLP 08G01 EPNI10
	PLLP 1/4-U10U EPNI10	PLLP 1/4-M5 EPNI10	GPLLP 0604 EPNI5	GPLLP 08G02 EPNI10
	PLLP 5/16-N01U EPNI10	PLLP 5/16-01 EPNI10	GPLLP 06M5 EPNI10	GPLLP 08G03 EPNI5
	PLLP 5/16-N02U EPNI10	PLLP 5/16-02 EPNI10	GPLLP 06M6 EPNI10	GPLLP 08G04 EPNI5
	PLLP 5/16-N03U EPNI5	PLLP 5/16-03 EPNI5	GPLLP 0801 EPNI10	GPLLP 10G01 EPNI5
	PLLP 5/16-N04U EPNI5	PLLP 5/16-04 EPNI5	GPLLP 0802 EPNI10	GPLLP 10G02 EPNI5
	PLLP 3/8-N01U EPNI5	PLLP 3/8-01 EPNI5	GPLLP 0803 EPNI5	GPLLP 10G03 EPNI5
	PLLP 3/8-N02U EPNI5	PLLP 3/8-02 EPNI5	GPLLP 0804 EPNI5	GPLLP 10G04 EPNI5
	PLLP 3/8-N03U EPNI5	PLLP 3/8-03 EPNI5	GPLLP 1001 EPNI5	GPLLP 12G01 EPNI5
	PLLP 3/8-N04U EPNI5	PLLP 3/8-04 EPNI5	GPLLP 1002 EPNI5	GPLLP 12G02 EPNI5
	PLLP 1/2-N02U EPNI5	PLLP 1/2-02 EPNI5	GPLLP 1003 EPNI5	GPLLP 12G03 EPNI5
	PLLP 1/2-N03U EPNI5	PLLP 1/2-03 EPNI5	GPLLP 1004 EPNI5	GPLLP 12G04 EPNI5
	PLLP 1/2-N04U EPNI5	PLLP 1/2-04 EPNI5	GPLLP 1202 EPNI5	
			GPLLP 1203 EPNI5	
			GPLLP 1204 EPNI5	

Model (ØD-R)

	ØD (Inch) - R (NPT) Bag Qty	ØD (Metric) - R (BSPT) Bag Qty	ØD (Metric) - R (BSPP) Bag Qty
PLF FEMALE ELBOW 	PLF 5/32-N01U EPNI10	GPLF 0401 EPNI.....10	GPLF 04G01 EPNI10
	PLF 5/32-N02U EPNI10	GPLF 0402 EPNI.....10	GPLF 04G02 EPNI10
	PLF 5/32-U10U EPNI10	GPLF 04M5 EPNI10	GPLF 06G01 EPNI10
	PLF 3/16-N01 EPNI10	GPLF 04M6 EPNI10	GPLF 06G02 EPNI10
	PLF 3/16-N02 EPNI10	GPLF 0601 EPNI10	GPLF 06G03 EPNI5
	PLF 3/16-U10U EPNI10	GPLF 0602 EPNI10	GPLF 08G01 EPNI10
	PLF 1/4-N01U EPNI10	GPLF 0603 EPNI5	GPLF 08G02 EPNI10
	PLF 1/4-N02U EPNI10	GPLF 06M5 EPNI10	GPLF 08G03 EPNI5
	PLF 1/4-N03U EPNI10	GPLF 06M6 EPNI10	GPLF 10G02 EPNI5
	PLF 1/4-U10U EPNI10	GPLF 0801 EPNI10	GPLF 10G03 EPNI5
	PLF 5/16-N01U EPNI10	GPLF 0802 EPNI10	GPLF 10G04 EPNI5
	PLF 5/16-N02U EPNI10		GPLF 12G02 EPNI5
	PLF 5/16-N03U EPNI10		GPLF 12G03 EPNI5
	PLF 3/8-N01U EPNI5		GPLF 12G04 EPNI5
	PLF 3/8-N02U EPNI5		
	PLF 3/8-N03U EPNI5		
	PLF 3/8-N04U EPNI5		

Model (ØD-R)				
	ØD (Inch) - R (NPT) Bag Qty	ØD (Inch) - R (BSPT) Bag Qty	ØD (Metric) - R (BSPT) Bag Qty	ØD (Metric) - R (BSPP) Bag Qty
PH MALE BANJO 	PH 5/32-N01U EPNI.....10	PH 5/32-M5 EPNI.....10	GPH 0401 EPNI10	GPH 04G01 EPNI.....10
	PH 5/32-U10U EPNI.....10	PH 5/32-R01 EPNI.....10	GPH 0402 EPNI10	GPH 04G02 EPNI.....10
	PH 3/16-N01U EPNI.....10	PH 1/4-M5 EPNI.....10	GPH 04M5 EPNI10	GPH 04G03 EPNI.....10
	PH 3/16-N02U EPNI.....10	PH 1/4-R01 EPNI.....10	GPH 0601 EPNI10	GPH 06G01 EPNI.....10
	PH 3/16-N03U EPNI.....10	PH 1/4-R02 EPNI.....10	GPH 0602 EPNI10	GPH 06G02 EPNI.....10
	PH 3/16-U10U EPNI.....10	PH 5/16-R01 EPNI.....10	GPH 0603 EPNI5	GPH 06G03 EPNI.....10
	PH 1/4-N01U EPNI.....10	PH 5/16-R02 EPNI.....10	GPH 06M5 EPNI10	GPH 08G01 EPNI.....10
	PH 1/4-N02U EPNI.....10	PH 5/16-R03 EPNI.....5	GPH 0801 EPNI10	GPH 08G02 EPNI.....10
	PH 1/4-U10U EPNI.....10	PH 3/8-R02 EPNI.....5	GPH 0802 EPNI10	GPH 08G03 EPNI.....5
	PH 5/16-N01U EPNI.....10	PH 3/8-R03 EPNI.....5	GPH 0803 EPNI5	GPH 08G04 EPNI.....5
	PH 5/16-N02U EPNI.....10	PH 3/8-R04 EPNI.....5	GPH 0804 EPNI5	GPH 10G02 EPNI.....5
	PH 5/16-N03U EPNI.....5	PH 1/2-R03 EPNI.....5	GPH 1002 EPNI5	GPH 10G03 EPNI.....5
	PH 3/8-N02U EPNI.....5	PH 1/2-R04 EPNI.....5	GPH 1003 EPNI5	GPH 10G04 EPNI.....5
	PH 3/8-N03U EPNI.....5		GPH 1004 EPNI5	GPH 12G03 EPNI.....5
	PH 3/8-N04U EPNI.....5		GPH 1202 EPNI5	GPH 12G04 EPNI.....5
	PH 1/2-N03U EPNI.....5		GPH 1203 EPNI5	
	PH 1/2-N04U EPNI.....5		GPH 1204 EPNI5	

Model (ØD-R)				
	ØD (Inch) - R (NPT) Bag Qty	ØD (Inch) - R (BSPT) Bag Qty	ØD (Metric) - R (BSPT) Bag Qty	ØD (Metric) - R (BSPP) Bag Qty
PHF FEMALE BANJO 	PHF 5/32-N01U EPNI.....10	PHF 5/32-M5 EPNI.....10	GPHF 0401 EPNI10	GPHF 04G01 EPNI10
	PHF 5/32-U10U EPNI.....10	PHF 5/32-R01 EPNI.....10	GPHF 0402 EPNI10	GPHF 06G01 EPNI10
	PHF 3/16-N01U EPNI.....10	PHF 1/4-M5 EPNI.....10	GPHF 04M5 EPNI10	GPHF 06G02 EPNI10
	PHF 3/16-N02U EPNI.....10	PHF 1/4-R01 EPNI.....10	GPHF 0601 EPNI10	GPHF 06G03 EPNI10
	PHF 3/16-U10U EPNI.....10	PHF 1/4-R02 EPNI.....10	GPHF 0602 EPNI10	GPHF 08G01 EPNI10
	PHF 1/4-N01U EPNI.....10	PHF 5/16-R01 EPNI.....10	GPHF 06M5 EPNI10	GPHF 08G02 EPNI10
	PHF 1/4-N02U EPNI.....10	PHF 5/16-R02 EPNI.....10	GPHF 0801 EPNI10	GPHF 08G03 EPNI5
	PHF 1/4-U10U EPNI.....10	PHF 5/16-R03 EPNI.....10	GPHF 0802 EPNI10	GPHF 10G02 EPNI5
	PHF 5/16-N01U EPNI.....10	PHF 3/8-R02 EPNI.....5	GPHF 0803 EPNI5	GPHF 10G03 EPNI5
	PHF 5/16-N02U EPNI.....10	PHF 3/8-R03 EPNI.....5	GPHF 1002 EPNI5	GPHF 12G03 EPNI5
	PHF 5/16-N03U EPNI.....10	PHF 1/2-R03 EPNI.....5	GPHF 1003 EPNI5	GPHF 12G04 EPNI5
	PHF 3/8-N02U EPNI.....5	PHF 1/2-R04 EPNI.....5	GPHF 1004 EPNI5	GPHF 04 G01-G01 EPNI10
	PHF 3/8-N03U EPNI.....5		GPHF 1202 EPNI5	GPHF 06 G01-G01 EPNI10
	PHF 1/2-N03U EPNI.....5		GPHF 1203 EPNI5	GPHF 06 G02-G02 EPNI10
	PHF 1/2-N04U EPNI.....5		GPHF 1204 EPNI5	GPHF 08 G01-G01 EPNI10
				GPHF 08 G02-G02 EPNI10
				GPHF 08 G03-G03 EPNI5
				GPHF 10 G02-G02 EPNI5
				GPHF 10 G03-G03 EPNI5
				GPHF 12 G03-G03 EPNI5
			GPHF 12 G04-G04 EPNI5	

*Single G Thread: Rc = BSPP, R = BSPT

Model (ØD-R)				
	ØD (Inch) - R (NPT) Bag Qty	ØD (Metric) - R (BSPT) Bag Qty	ØD (Metric) - R (BSPP) Bag Qty	
POL HEX HOLED BANJO 	POL 5/32-N01U EPNI.....10	GPOL 0401 EPNI10	GPOL 04G01 EPNI10	
	POL 5/32-U10U EPNI.....10	GPOL 0402 EPNI10	GPOL 06G01 EPNI10	
	POL 3/16-N01 EPNI.....10	GPOL 04M5 EPNI10	GPOL 06G02 EPNI10	
	POL 3/16-N02 EPNI.....10	GPOL 0601 EPNI10	GPOL 08G01 EPNI10	
	POL 3/16-N03 EPNI.....10	GPOL 0602 EPNI10	GPOL 08G02 EPNI10	
	POL 3/16-U10U EPNI.....10	GPOL 0603 EPNI5	GPOL 08G03 EPNI5	
	POL 1/4-N01U EPNI.....10	GPOL 06M5 EPNI10	GPOL 10G02 EPNI5	
	POL 1/4-N02U EPNI.....10	GPOL 0801 EPNI10	GPOL 1202 EPNI5	
	POL 1/4-N03U EPNI.....5	GPOL 0802 EPNI10	GPOL 12G03 EPNI5	
	POL 1/4-U10U EPNI.....10	GPOL 0803 EPNI5	GPOL 12G04 EPNI5	
	POL 5/16-N01U EPNI.....10	GPOL 0804 EPNI5		
	POL 5/16-N02U EPNI.....10	GPOL 1002 EPNI5		
	POL 5/16-N03U EPNI.....5	GPOL 1003 EPNI5		
	POL 3/8-N02U EPNI.....5	GPOL 1004 EPNI5		
	POL 3/8-N03U EPNI.....5	GPOL 1203 EPNI5		
	POL 3/8-N04U EPNI.....5	GPOL 1204 EPNI5		
	POL 1/2-N03U EPNI.....5			
	POL 1/2-N04U EPNI.....5			

Model (ØD-R)

	ØD (Inch) - R (NPT) Bag Qty	ØD (Metric) - R (BSPT) Bag Qty	ØD (Metric) -R (BSPP) Bag Qty
PA DUAL MALE BANJO 	PA 5/32-U10U EPNI10	GPA 0401 EPNI10	GPA 04G01 EPNI10
	PA 3/16-N01U EPNI10	GPA 0402 EPNI10	GPA 04G02 EPNI10
	PA 1/4-N01U EPNI10	GPA 0403 EPNI5	GPA 04G03 EPNI5
	PA 5/16-N02U EPNI5	GPA 04M5 EPNI10	GPA 06G01 EPNI10
	PA 3/8-N03U EPNI5	GPA 0601 EPNI10	GPA 06G02 EPNI10
	PA 1/2-N04U EPNI5	GPA 0602 EPNI10	GPA 06G03 EPNI5
		GPA 0603 EPNI5	GPA 08G01 EPNI5
		GPA 0801 EPNI5	GPA 08G02 EPNI5
		GPA 0802 EPNI5	GPA 08G03 EPNI5
		GPA 0803 EPNI5	GPA 08G04 EPNI5
		GPA 0804 EPNI5	GPA 10G02 EPNI5
		GPA 1002 EPNI5	GPA 10G03 EPNI5
		GPA 1003 EPNI5	GPA 10G04 EPNI5
		GPA 1004 EPNI5	GPA 12G03 EPNI5
		GPA 1203 EPNI5	GPA 12G04 EPNI5
		GPA 1204 EPNI5	

Model (ØD-R)

	ØD (Inch) - R (NPT) Bag Qty	ØD (Metric) - R (BSPT) Bag Qty	ØD (Metric) -R (BSPP) Bag Qty
PAF DUAL FEMALE BANJO 	PAF 5/32-U10U EPNI10	GPAF 04M5 EPNI10	GPAF 06G01 EPNI10
	PAF 3/16-N01U EPNI10	GPAF 0601 EPNI10	GPAF 08G02 EPNI5
	PAF 1/4-N01U EPNI10	GPAF 0802 EPNI5	GPAF 10G03 EPNI5
	PAF 5/16-N02U EPNI5	GPAF 1003 EPNI5	GPAF 12G04 EPNI5
	PAF 3/8-N03U EPNI5	GPAF 1204 EPNI5	
	PAF 1/2-N04U EPNI5		

Model (ØD-R)

PH(2) DOUBLE UNIVERSAL ELBOW			
ØD (Metric) - R (BSPT) Bag Qty	ØD (Metric) -R (BSPP) Bag Qty		
GPH 0401(2) EPNI 5	GPH 04G01(2) EPNI 10		
GPH 0402(2) EPNI 5	GPH 04G02(2) EPNI 5		
GPH 0403(2) EPNI 5	GPH 04G03(2) EPNI 5		
GPH 0601(2) EPNI 5	GPH 06G01(2) EPNI 5		
GPH 0602(2) EPNI 5	GPH 06G02(2) EPNI 5		
GPH 0603(2) EPNI 5	GPH 06G03(2) EPNI 5		
GPH 0801(2) EPNI 5	GPH 08G01(2) EPNI 5		
GPH 0802(2) EPNI 5	GPH 08G02(2) EPNI 5		
GPH 0803(2) EPNI 5	GPH 08G03(2) EPNI 5		
GPH 0804(2) EPNI 5	GPH 08G04(2) EPNI 5		
GPH 1002(2) EPNI 5	GPH 10G02(2) EPNI 5		
GPH 1003(2) EPNI 5	GPH 10G03(2) EPNI 5		
GPH 1004(2) EPNI 5	GPH 10G04(2) EPNI 5		
GPH 1202(2) EPNI 3	GPH 12G03(2) EPNI 3		
GPH 1203(2) EPNI 3	GPH 12G04(2) EPNI 3		
GPH 1204(2) EPNI 3			

Model (ØD-R)

PH(3) TRIPLE UNIVERSAL ELBOW			
ØD (Metric) - R (BSPT) Bag Qty	ØD (Metric) -R (BSPP) Bag Qty		
GPH 0401(3) EPNI 5	GPH 04G01(3) EPNI 5		
GPH 0402(3) EPNI 5	GPH 04G02(3) EPNI 5		
GPH 0403(3) EPNI 5	GPH 04G03(3) EPNI 5		
GPH 0601(3) EPNI 5	GPH 06G01(3) EPNI 5		
GPH 0602(3) EPNI 5	GPH 06G02(3) EPNI 5		
GPH 0603(3) EPNI 5	GPH 06G03(3) EPNI 5		
GPH 0801(3) EPNI 5	GPH 0801(3) EPNI 5		
GPH 0802(3) EPNI 5	GPH 0802(3) EPNI 5		
GPH 0803(3) EPNI 5	GPH 0803(3) EPNI 5		
GPH 0804(3) EPNI 5	GPH 0804(3) EPNI 5		
GPH 1002(3) EPNI 4	GPH 10G02(3) EPNI 4		
GPH 1003(3) EPNI 4	GPH 10G03(3) EPNI 4		
GPH 1004(3) EPNI 4	GPH 10G04(3) EPNI 4		
GPH 1202(3) EPNI 3	GPH 12G03(3) EPNI 3		
GPH 1203(3) EPNI 3	GPH 12G04(3) EPNI 3		
GPH 1204(3) EPNI 3			

Model (ØD-R)

PA(2) DOUBLE BRANCH A			
ØD (Metric) - R (BSPT) Bag Qty	ØD (Metric) -R (BSPP) Bag Qty		
GPA 0401(2) EPNI 5	GPA 04G01(2) EPNI 5		
GPA 0402(2) EPNI 5	GPA 04G02(2) EPNI 5		
GPA 0403(2) EPNI 5	GPA 04G03(2) EPNI 5		
GPA 04M5(2) EPNI 5	GPA 06G01(2) EPNI 5		
GPA 0601(2) EPNI 5	GPA 06G02(2) EPNI 5		
GPA 0602(2) EPNI 5	GPA 06G03(2) EPNI 5		
GPA 0603(2) EPNI 5	GPA 08G01(2) EPNI 5		
GPA 0801(2) EPNI 5	GPA 08G02(2) EPNI 5		
GPA 0802(2) EPNI 5	GPA 08G03(2) EPNI 5		
GPA 0803(2) EPNI 5	GPA 08G04(2) EPNI 5		
GPA 0804(2) EPNI 5	GPA 10G02(2) EPNI 4		
GPA 1002(2) EPNI 4	GPA 10G03(2) EPNI 4		
GPA 1003(2) EPNI 4	GPA 10G04(2) EPNI 4		
GPA 1004(2) EPNI 4	GPA 12G03(2) EPNI 3		
GPA 1202(2) EPNI 3	GPA 12G04(2) EPNI 3		
GPA 1203(2) EPNI 3			
GPA 1204(2) EPNI 3			

Model (ØD-R)

PA (3) TRIPLE BRANCH A			
ØD (Metric) - R (BSPT) Bag Qty	ØD (Metric) -R (BSPP) Bag Qty		
GPA 0401(3) EPNI 5	GPA 04G01(3) EPNI 5		
GPA 0402(3) EPNI 5	GPA 04G02(3) EPNI 5		
GPA 0403(3) EPNI 5	GPA 04G03(3) EPNI 5		
GPA 0601(3) EPNI 5	GPA 06G01(3) EPNI 5		
GPA 0602(3) EPNI 5	GPA 06G02(3) EPNI 5		
GPA 0603(3) EPNI 5	GPA 06G03(3) EPNI 5		
GPA 0801(3) EPNI 4	GPA 08G01(3) EPNI 4		
GPA 0802(3) EPNI 4	GPA 08G02(3) EPNI 4		
GPA 0803(3) EPNI 4	GPA 08G03(3) EPNI 4		
GPA 0804(3) EPNI 4	GPA 08G04(3) EPNI 4		
GPA 1002(3) EPNI 3	GPA 10G02(3) EPNI 3		
GPA 1003(3) EPNI 3	GPA 10G03(3) EPNI 3		
GPA 1004(3) EPNI 3	GPA 10G04(3) EPNI 3		
GPA 1202(3) EPNI 3	GPA 12G03(3) EPNI 3		
GPA 1203(3) EPNI 3	GPA 12G04(3) EPNI 3		
GPA 1204(3) EPNI 3			

Model (ØD-R)

	ØD (Inch) - R (NPT)	Bag Qty	ØD (Inch) - R (BSPT)	Bag Qty	ØD (Metric) - R (BSPT)	Bag Qty	ØD (Metric) - R (BSPP)	Bag Qty
PT MALE BRANCH TEE 	PT 5/32-N01U EPNI	10	PT 5/32-R01 EPNI	10	GPT 0401 EPNI	10	GPT 04G01 EPNI	10
	PT 5/32-N02U EPNI	10	PT 5/32-R02 EPNI	10	GPT 0402 EPNI	10	GPT 04G02 EPNI	10
	PT 5/32-N03U EPNI	10	PT 5/32-R03 EPNI	10	GPT 0403 EPNI	10	GPT 04G03 EPNI	10
	PT 5/32-U10U EPNI	10	PT 3/16-R01 EPNI	10	GPT 04M5 EPNI	10	GPT 06G01 EPNI	10
	PT 3/16-N01U EPNI	10	PT 3/16-R02 EPNI	10	GPT 04M6 EPNI	10	GPT 06G02 EPNI	10
	PT 3/16-N02U EPNI	10	PT 3/16-R03 EPNI	10	GPT 0601 EPNI	10	GPT 06G03 EPNI	10
	PT 3/16-N03U EPNI	10	PT 1/4-R01 EPNI	10	GPT 0602 EPNI	10	GPT 06G04 EPNI	5
	PT 3/16-U10U EPNI	10	PT 1/4-R02 EPNI	10	GPT 0603 EPNI	10	GPT 08G01 EPNI	10
	PT 1/4-N01U EPNI	10	PT 1/4-R03 EPNI	10	GPT 0604 EPNI	5	GPT 08G02 EPNI	10
	PT 1/4-N02U EPNI	10	PT 1/4-R04 EPNI	10	GPT 06M5 EPNI	10	GPT 08G03 EPNI	10
	PT 1/4-N03U EPNI	10	PT 5/16-R01 EPNI	10	GPT 06M6 EPNI	10	GPT 06M6 EPNI	10
	PT 1/4-N04U EPNI	10	PT 5/16-R02 EPNI	10	GPT 0801 EPNI	10	GPT 10G01 EPNI	5
	PT 1/4-U10U EPNI	10	PT 5/16-R03 EPNI	5	GPT 0802 EPNI	10	GPT 10G02 EPNI	5
	PT 5/16-N01U EPNI	10	PT 5/16-R04 EPNI	5	GPT 0803 EPNI	10	GPT 10G03 EPNI	5
	PT 5/16-N02U EPNI	10	PT 3/8-R01 EPNI	5	GPT 0804 EPNI	5	GPT 10G04 EPNI	5
	PT 5/16-N03U EPNI	5	PT 3/8-R02 EPNI	5	GPT 1001 EPNI	5	GPT 12G01 EPNI	5
	PT 5/16-N04U EPNI	5	PT 3/8-R03 EPNI	5	GPT 1002 EPNI	5	GPT 12G02 EPNI	5
	PT 3/8-N01U EPNI	5	PT 3/8-R04 EPNI	5	GPT 1003 EPNI	5	GPT 12G03 EPNI	5
	PT 3/8-N02U EPNI	5	PT 1/2-R01 EPNI	5	GPT 1004 EPNI	5	GPT 12G04 EPNI	5
	PT 3/8-N03U EPNI	5	PT 1/2-R02 EPNI	5	GPT 1201 EPNI	5	GPT 14G03 EPNI	4
	PT 3/8-N04U EPNI	5	PT 1/2-R03 EPNI	5	GPT 1202 EPNI	5	GPT 14G04 EPNI	4
	PT 1/2-N01U EPNI	5	PT 1/2-R04 EPNI	5	GPT 1203 EPNI	5	GPT 16G03 EPNI	4
	PT 1/2-N02U EPNI	5			GPT 1204 EPNI	5	GPT 16G04 EPNI	4
	PT 1/2-N03U EPNI	5			GPT 1403 EPNI	4		
PT 1/2-N04U EPNI	5			GPT 1404 EPNI	4			
				GPT 1603 EPNI	4			
				GPT 1604 EPNI	4			

Model (ØD-R)

	ØD (Inch) - R (NPT)	Bag Qty	ØD (Inch) - R (BSPT)	Bag Qty	ØD (Inch) - R (BSPT)	Bag Qty	ØD (Metric) - R (BSPP)	Bag Qty
PST MALE RUN TEE 	PST 5/32-N01U EPNI	10	PST 5/32-R01 EPNI	10	GPST 0401 EPNI	10	GPST 04G01 EPNI	10
	PST 5/32-N02U EPNI	10	PST 5/32-R02 EPNI	10	GPST 0402 EPNI	10	GPST 04G02 EPNI	10
	PST 5/32-U10U EPNI	10	PST 3/16-R01 EPNI	10	GPST 0403 EPNI	10	GPST 04G03 EPNI	10
	PST 3/16-N01U EPNI	10	PST 3/16-R02 EPNI	10	GPST 04M5 EPNI	10	GPST 06G01 EPNI	10
	PST 3/16-N02U EPNI	10	PST 3/16-R03 EPNI	10	GPST 04M6 EPNI	10	GPST 06G02 EPNI	10
	PST 3/16-N03U EPNI	10	PST 1/4-R01 EPNI	10	GPST 0601 EPNI	10	GPST 06G03 EPNI	10
	PST 3/16-U10U EPNI	10	PST 1/4-R02 EPNI	10	GPST 0602 EPNI	10	GPST 06G04 EPNI	5
	PST 1/4-N01U EPNI	10	PST 1/4-R03 EPNI	10	GPST 0603 EPNI	10	GPST 08G01 EPNI	10
	PST 1/4-N02U EPNI	10	PST 1/4-R04 EPNI	10	GPST 0604 EPNI	5	GPST 08G02 EPNI	10
	PST 1/4-N03U EPNI	10	PST 5/16-R02 EPNI	10	GPST 06M5 EPNI	10	GPST 08G03 EPNI	5
	PST 1/4-U10U EPNI	10	PST 5/16-R03 EPNI	10	GPST 06M6 EPNI	10	GPST 08G04 EPNI	5
	PST 5/16-N01U EPNI	10	PST 5/16-R04 EPNI	5	GPST 0801 EPNI	10	GPST 10G01 EPNI	5
	PST 5/16-N02U EPNI	10	PST 3/8-R01 EPNI	5	GPST 0802 EPNI	10	GPST 10G02 EPNI	5
	PST 5/16-N03U EPNI	10	PST 3/8-R02 EPNI	5	GPST 0803 EPNI	5	GPST 10G03 EPNI	5
	PST 5/16-N04U EPNI	5	PST 3/8-R03 EPNI	5	GPST 0804 EPNI	5	GPST 10G04 EPNI	5
	PST 3/8-N01U EPNI	5	PST 3/8-R04 EPNI	5	GPST 1001 EPNI	5	GPST 12G01 EPNI	5
	PST 3/8-N02U EPNI	5	PST 1/2-R02 EPNI	5	GPST 1002 EPNI	5	GPST 12G02 EPNI	5
	PST 3/8-N03U EPNI	5	PST 1/2-R03 EPNI	5	GPST 1003 EPNI	5	GPST 12G03 EPNI	5
	PST 3/8-N04U EPNI	5	PST 1/2-R04 EPNI	5	GPST 1004 EPNI	5	GPST 12G04 EPNI	5
	PST 1/2-N02U EPNI	5			GPST 1201 EPNI	5	GPST 14G03 EPNI	4
	PST 1/2-N03U EPNI	5			GPST 1202 EPNI	5	GPST 14G04 EPNI	4
	PST 1/2-N04U EPNI	5			GPST 1203 EPNI	5	GPST 16G03 EPNI	4
					GPST 1204 EPNI	5	GPST 16G04 EPNI	4
					GPST 1403 EPNI	4		
				GPST 1404 EPNI	4			
				GPST 1603 EPNI	4			
				GPST 1604 EPNI	4			

Model (ØD-R)

	ØD (Inch) - R (NPT)	Bag Qty	ØD (Inch) - R (BSPT)	Bag Qty	ØD (Metric) - R (BSPT)	Bag Qty	ØD (Metric) - R (BSPP)	Bag Qty
PWT MALE Y 	PWT 5/32-N01U EPNI	10	PWT 5/32-R01 EPNI	10	GPWT 0401 EPNI	10	GPWT 04G01 EPNI	10
	PWT 5/32-N02U EPNI	10	PWT 5/32-R02 EPNI	10	GPWT 0402 EPNI	10	GPWT 04G02 EPNI	10
	PWT 5/32-U10U EPNI	10	PWT 3/16-R01 EPNI	10	GPWT 0403 EPNI	10	GPWT 04G03 EPNI	10
	PWT 3/16-N01U EPNI	10	PWT 3/16-R02 EPNI	10	GPWT 04M5 EPNI	10	GPWT 06G01 EPNI	10
	PWT 3/16-N02U EPNI	10	PWT 3/16-R03 EPNI	10	GPWT 04M6 EPNI	10	GPWT 06G02 EPNI	10
	PWT 3/16-N03U EPNI	10	PWT 1/4-R01 EPNI	10	GPWT 0601 EPNI	10	GPWT 06G03 EPNI	5
	PWT 3/16-U10U EPNI	10	PWT 1/4-R02 EPNI	10	GPWT 0602 EPNI	10	GPWT 06G04 EPNI	5
	PWT 1/4-N01U EPNI	10	PWT 1/4-R03 EPNI	10	GPWT 0603 EPNI	5	GPWT 08G01 EPNI	10
	PWT 1/4-N02U EPNI	10	PWT 5/16-R01 EPNI	10	GPWT 0604 EPNI	5	GPWT 08G02 EPNI	10
	PWT 1/4-N03U EPNI	10	PWT 5/16-R02 EPNI	10	GPWT 06M5 EPNI	10	GPWT 08G03 EPNI	5
	PWT 1/4-U10U EPNI	10	PWT 5/16-R03 EPNI	5	GPWT 06M6 EPNI	10	GPWT 08G04 EPNI	5
	PWT 5/16-N01U EPNI	10	PWT 5/16-R04 EPNI	5	GPWT 0801 EPNI	10	GPWT 10G01 EPNI	5
	PWT 5/16-N02U EPNI	10	PWT 3/8-R01 EPNI	5	GPWT 0802 EPNI	10	GPWT 10G02 EPNI	5
	PWT 5/16-N03U EPNI	5	PWT 3/8-R02 EPNI	5	GPWT 0803 EPNI	5	GPWT 10G03 EPNI	5
	PWT 5/16-N04U EPNI	5	PWT 3/8-R03 EPNI	5	GPWT 0804 EPNI	5	GPWT 10G04 EPNI	5
	PWT 3/8-N01U EPNI	5	PWT 3/8-R04 EPNI	5	GPWT 1001 EPNI	5	GPWT 12G01 EPNI	5
	PWT 3/8-N02U EPNI	5	PWT 1/2-R02 EPNI	5	GPWT 1002 EPNI	5	GPWT 12G02 EPNI	5
	PWT 3/8-N03U EPNI	5	PWT 1/2-R03 EPNI	5	GPWT 1003 EPNI	5	GPWT 12G03 EPNI	5
	PWT 3/8-N04U EPNI	5	PWT 1/2-R04 EPNI	5	GPWT 1004 EPNI	5	GPWT 12G04 EPNI	5
	PWT 1/2-N02U EPNI	5			GPWT 1201 EPNI	5		
	PWT 1/2-N03U EPNI	5			GPWT 1202 EPNI	5		
	PWT 1/2-N04U EPNI	5			GPWT 1203 EPNI	5		
					GPWT 1204 EPNI	5		

Model (ØD-R)				
	ØD (Inch) - R (NPT)	Bag Qty	ØD (Inch) - R (BSPT)	Bag Qty
PXT MALE DOUBLE Y 	PXT 5/32-N01U EPNI.....5		PXT 1/4-R01 EPNI5	
	PXT 5/32-N02U EPNI.....5		PXT 1/4-R02 EPNI5	
	PXT 1/4-N01U EPNI.....5			
	PXT 1/4-N02U EPNI.....5			
	ØD (Metric) - R (BSPT)	Bag Qty	ØD (Metric) -R (BSPP)	Bag Qty
	GPXT 0401 EPNI5		GPXT 04G01 EPNI.....5	
	GPXT 0402 EPNI5		GPXT 04G02 EPNI.....5	
	GPXT 0601 EPNI5		GPXT 06G01 EPNI.....5	
	GPXT 0602 EPNI5		GPXT 06G02 EPNI.....5	



Model (ØD-R)	
	ØD (Metric) -R (BSPP)
PGT(1) SINGLE UNIVERSAL TEE 	PGT 04G01(1)EPNI
	PGT 06G01(1)EPNI
	PGT 06G02(1)EPNI
	PGT 08G01(1)EPNI
	PGT 08G02(1)EPNI
	PGT 08G03(1)EPNI
	PGT 10G02(1)EPNI
	PGT 10G03(1)EPNI
	PGT 12G03(1)EPNI
	PGT 12G04(1)EPNI



Model (ØD-R)						
	ØD (Inch) - R (NPT)	Bag Qty	ØD (Metric) - R (BSPT)	Bag Qty	ØD (Metric) - R (BSPP)	Bag Qty
PTF FEMALE BRANCH TEE 	PTF 5/32-N01U EPNI.....10		GPTF 0401 EPNI.....10		GPTF 04G01 EPNI.....10	
	PTF 5/32-N02U EPNI.....10		GPTF 0402 EPNI.....10		GPTF 04G02 EPNI.....10	
	PTF 5/32-U10U EPNI.....10		GPTF 04M5 EPNI.....10		GPTF 06G01 EPNI.....10	
	PTF 3/16-N01U EPNI.....10		GPTF 04M6 EPNI.....10		GPTF 06G02 EPNI.....10	
	PTF 3/16-N02U EPNI.....10		GPTF 0601 EPNI.....10		GPTF 06G03 EPNI.....5	
	PTF 3/16-U10U EPNI.....10		GPTF 0602 EPNI.....10		GPTF 08G01 EPNI.....10	
	PTF 1/4-N01U EPNI.....10		GPTF 0603 EPNI.....5		GPTF 08G02 EPNI.....10	
	PTF 1/4-N02U EPNI.....10		GPTF 06M5 EPNI.....10		GPTF 08G03 EPNI.....5	
	PTF 1/4-N03U EPNI.....10		GPTF 06M6 EPNI.....10		GPTF 10G02 EPNI.....5	
	PTF 1/4-U10U EPNI.....10		GPTF 0801 EPNI.....10		GPTF 10G03 EPNI.....5	
	PTF 5/16-N01U EPNI.....10		GPTF 0802 EPNI.....10		GPTF 10G04 EPNI.....5	
	PTF 5/16-N02U EPNI.....10		GPTF 0803 EPNI.....5		GPTF 12G02 EPNI.....5	
	PTF 5/16-N03U EPNI.....5		GPTF 1002 EPNI.....5		GPTF 12G03 EPNI.....5	
	PTF 3/8-N02U EPNI.....5		GPTF 1003 EPNI.....5		GPTF 12G04 EPNI.....5	
	PTF 3/8-N03U EPNI.....5		GPTF 1004 EPNI.....5			
	PTF 3/8-N04U EPNI.....5					



Model (ØD-R)	
	ØD (Metric) -R (BSPP)
PGT(2) DOUBLE UNIVERSAL TEE 	PGT 04G01(2)EPNI
	PGT 06G01(2)EPNI
	PGT 06G02(2)EPNI
	PGT 08G01(2)EPNI
	PGT 08G02(2)EPNI
	PGT 08G03(2)EPNI
	PGT 10G02(2)EPNI
	PGT 10G03(2)EPNI
	PGT 12G03(2)EPNI
	PGT 12G04(2)EPNI



Model (ØD-R)	
	ØD (Metric) -R (BSPP)
PGT(3) TRIPLE UNIVERSAL TEE 	PGT 04G01(3)EPNI
	PGT 06G01(3)EPNI
	PGT 06G02(3)EPNI
	PGT 08G01(3)EPNI
	PGT 08G02(3)EPNI
	PGT 08G03(3)EPNI
	PGT 10G02(3)EPNI
	PGT 10G03(3)EPNI
	PGT 12G03(3)EPNI
	PGT 12G04(3)EPNI



Model (ØD-R)								
	ØD (Inch) - R (NPT)	Bag Qty	ØD (Inch) - R (BSPT)	Bag Qty	ØD (Metric) - R (BSPT)	Bag Qty	ØD (Metric) -R (BSPP)	Bag Qty
PMF BULKHEAD FEMALE STRAIGHT 	PMF 5/32-N01U EPNI.....10		PMF 5/32-Rc01 EPNI.....10		GPMF 0401 EPNI.....10		GPMF 04G01 EPNI.....10	
	PMF 3/16-N01U EPNI.....10		PMF 5/32-Rc02 EPNI.....10		GPMF 0402 EPNI.....10		GPMF 04G02 EPNI.....10	
	PMF 3/16-N02U EPNI.....10		PMF 5/32-Rc03 EPNI.....10		GPMF 0403 EPNI.....10		GPMF 04G03 EPNI.....10	
	PMF 1/4-N01U EPNI.....10		PMF 3/16-Rc01 EPNI.....10		GPMF 0601 EPNI.....10		GPMF 06G01 EPNI.....10	
	PMF 1/4-N02U EPNI.....10		PMF 3/16-Rc02 EPNI.....10		GPMF 0602 EPNI.....10		GPMF 06G02 EPNI.....10	
	PMF 5/16-N01U EPNI.....10		PMF 1/4-Rc01 EPNI.....10		GPMF 0603 EPNI.....10		GPMF 06G03 EPNI.....10	
	PMF 5/16-N02U EPNI.....10		PMF 1/4-Rc02 EPNI.....10		GPMF 0801 EPNI.....10		GPMF 08G01 EPNI.....10	
	PMF 5/16-N03U EPNI.....10		PMF 1/4-Rc03 EPNI.....10		GPMF 0802 EPNI.....10		GPMF 08G02 EPNI.....10	
	PMF 3/8-N02U EPNI.....5		PMF 5/16-Rc01 EPNI.....10		GPMF 0803 EPNI.....10		GPMF 08G03 EPNI.....10	
	PMF 3/8-N03U EPNI.....5		PMF 5/16-Rc02 EPNI.....10		GPMF 0804 EPNI.....5		GPMF 08G04 EPNI.....5	
	PMF 1/2-N02U EPNI.....5		PMF 5/16-Rc03 EPNI.....10		GPMF 1001 EPNI.....5		GPMF 10G01 EPNI.....5	
	PMF 1/2-N03U EPNI.....5		PMF 5/16-Rc04 EPNI.....5		GPMF 1002 EPNI.....5		GPMF 10G02 EPNI.....5	
	PMF 1/2-N04U EPNI.....5		PMF 3/8-Rc01 EPNI.....5		GPMF 1003 EPNI.....5		GPMF 10G03 EPNI.....5	
			PMF 3/8-Rc02 EPNI.....5		GPMF 1004 EPNI.....5		GPMF 10G04 EPNI.....5	
			PMF 3/8-Rc03 EPNI.....5		GPMF 1201 EPNI.....5		GPMF 12G01 EPNI.....5	
			PMF 3/8-Rc04 EPNI.....5		GPMF 1202 EPNI.....5		GPMF 12G02 EPNI.....5	
			PMF 1/2-Rc01 EPNI.....5		GPMF 1203 EPNI.....5		GPMF 12G03 EPNI.....5	
			PMF 1/2-Rc02 EPNI.....5		GPMF 1204 EPNI.....5		GPMF 12G04 EPNI.....5	
			PMF 1/2-Rc03 EPNI.....5					
			PMF 1/2-Rc04 EPNI.....5					

Model (ØD)					
	ØD (Inch)	Bag Qty		ØD (Inch)	Bag Qty
PMM BULKHEAD UNION 	PMM 5/32 EPNI.....10		PPM BULKHEAD UNION PLASTIC 	PPLM 5/32.....10	
	PMM 3/16 EPNI.....10			PPLM 3/16.....10	
	PMM 1/4 EPNI.....10			PPLM 1/4.....10	
	PMM 5/16 EPNI.....10			PPLM 5/16.....10	
	PMM 3/8 EPNI.....5			PPLM 3/8.....5	
	PMM 1/2 EPNI.....5			PPLM 1/2.....5	
	ØD (Metric)	Bag Qty		ØD (Metric)	Bag Qty
	GPMM 04 EPNI.....10			GPLM 04.....10	
	GPMM 06 EPNI.....10			GPLM 06.....10	
	GPMM 08 EPNI.....10			GPLM 08.....5	
	GPMM 10 EPNI.....5			GPLM 10.....5	
	GPMM 12 EPNI.....5			GPLM 12.....5	

Model (ØD)							
ØD (Inch)		Bag Qty	ØD (Inch)		Bag Qty		
PUC UNION STRAIGHT 	PUC 5/32.....	10	PUL UNION ELBOW 	PUL 5/32.....	10		
	PUC 3/16.....	10		PUL 3/16.....	10		
	PUC 1/4.....	10		PUL 1/4.....	10		
	PUC 5/16.....	10		PUL 5/16.....	10		
	PUC 3/8.....	10		PUL 3/8.....	5		
	PUC 1/2.....	5		PUL 1/2.....	5		
	PUC 1/2-1/4.....	5					
	ØD (Metric)			Bag Qty	ØD (Metric)		Bag Qty
	GPUC 04.....			10	GPUL 04.....		10
	GPUC 06.....			10	GPUL 06.....		10
GPUC 08.....		10	GPUL 08.....		10		
GPUC 10.....		10	GPUL 10.....		5		
GPUC 12.....		5	GPUL 12.....		5		
GPUC 14.....		5	GPUL 14.....		5		
GPUC 16.....		5	GPUL 16.....		5		
			PUT UNION TEE 				
			PUT 5/32.....10 PUT 3/16.....10 PUT 1/4.....10 PUT 5/16.....10 PUT 3/8.....5 PUT 3/8-1/4.....5 PUT 1/2.....5 PUT 1/2-1/4.....5 ØD (Metric) Bag Qty GPUT 04.....10 GPUT 06.....10 GPUT 08.....10 GPUT 10.....5 GPUT 12.....5 GPUT 14.....4 GPUT 16.....4				

Model (ØD)			Model (ØD-ØD2)				
ØD (Inch)		Bag Qty	ØD (Inch)		Bag Qty		
PY UNION Y 	PY 5/32.....	10	PZA UNION CROSS 	PZA 5/32.....	10		
	PY 3/16.....	10		PZA 3/16.....	10		
	PY 1/4.....	10		PZA 1/4.....	10		
	PY 5/16.....	10		PZA 5/16.....	5		
	PY 3/8.....	5		PZA 3/8.....	5		
	PY 1/2.....	5		PZA 1/2.....	5		
	ØD (Metric)			Bag Qty	ØD (Metric)		Bag Qty
	GPY 04.....			10	GPZA 04.....		10
	GPY 06.....			10	GPZA 06.....		10
	GPY 08.....			10	GPZA 08.....		5
GPY 10.....		5	GPZA 10.....		5		
GPY 12.....		5	GPZA 12.....		5		
GPY 14.....		4					
GPY 16.....		4					
			PZA22/31 REDUCER CROSS 				
			PZA22 1/2-3/8.....5 PZA22 3/8-5/16.....5 PZA22 5/16-1/4.....5 PZA31 1/2-3/8.....5 PZA31 3/8-5/16.....5 PZA31 5/16-1/4.....5 ØD (Metric) Bag Qty GPZA22 0806.....5 GPZA22 1008.....5 GPZA22 1210.....5 GPZA31 0806.....5 GPZA31 1008.....5 GPZA31 1210.....5				

Model (ØD-ØD2)					
ØD(Inch) - ØD2(Inch)		Bag Qty	ØD(Inch) - ØD2(Inch)		Bag Qty
PG REDUCER 	PG 3/16-5/32.....	10	PUG REDUCER TEE 	PUG 1/4-5/32.....	10
	PG 1/4-5/32.....	10		PUG 5/16-5/32.....	10
	PG 1/4-3/16.....	10		PUG 5/16-1/4.....	10
	PG 5/16-5/32.....	10		PUG 3/8-1/4.....	5
	PG 5/16-1/4.....	10		PUG 3/8-5/16.....	5
	PG 3/8-5/16.....	10		PUG 1/2-5/16.....	5
	PG 3/8-1/4.....	10		PUG 1/2-3/8.....	5
	PG 1/2-5/16.....	5			
	PG 1/2-3/8.....	5			
	ØD(Metric) - ØD2(Metric)			Bag Qty	ØD(Metric) - ØD2(Metric)
GPG 0403.....		10	GPUG 0604.....		10
GPG 0604.....		10	GPUG 0804.....		10
GPG 0804.....		10	GPUG 0806.....		10
GPG 0806.....		10	GPUG 1006.....		5
GPG 1006.....		10	GPUG 1008.....		5
GPG 1008.....		10	GPUG 1208.....		5
GPG 1208.....		5	GPUG 1210.....		5
GPG 1210.....		5			
GPG 1612.....		5			
			PW REDUCER Y 		
			PW 3/16-5/32.....10 PW 1/4-5/32.....10 PW 1/4-3/16.....10 PW 5/16-1/4.....10 PW 3/8-1/4.....5 PW 3/8-5/16.....5 PW 1/2-5/16.....5 PW 1/2-3/8.....5 PW 1/2-1/2-1/4.....5 ØD(Metric) - ØD2(Metric) Bag Qty GPW 0604.....10 GPW 0804.....10 GPW 0806.....10 GPW 1006.....5 GPW 1008.....5 GPW 1208.....5 GPW 1210.....5		

Model (ØD-ØD2)							
ØD(Inch) - ØD2(Inch)		Bag Qty	ØD(Inch) - ØD2(Inch)		Bag Qty		
PKD MALE REDUCER TRIPLE BRANCH 	PKD 3/16-5/32-N01U EPNI...5	5	PKG REDUCER TRIPLE BRANCH 	PKG 3/16-5/32.....	5		
	PKD 1/4-5/32-N01U EPNI...5	5		PKG 5/16-5/32.....	5		
	PKD 5/16-5/32-N02U EPNI...5	5		PKG 5/16-3/16.....	5		
	PKD 5/16-3/16-N02U EPNI...5	5		PKG 5/16-1/4.....	5		
	PKD 5/16-1/4-N02U EPNI...5	5		PKG 3/8-1/4.....	5		
	PKD 5/16-1/4-N03U EPNI...5	5		PKG 3/8-5/16.....	5		
	PKD 3/8-1/4-N02U EPNI...5	5					
	PKD 3/8-5/16-N03U EPNI...5	5					
	ØD(Metric) - ØD2(Metric)			Bag Qty	ØD(Metric) - ØD2(Metric)		Bag Qty
	GPKD 0604-01 EPNI.....5			5	GPKG 0604.....		5
GPKD 0604-02 EPNI.....5		5	GPKG 0804.....		5		
GPKD 0804-02 EPNI.....5		5	GPKG 0806.....		5		
GPKD 0806-02 EPNI.....5		5	GPKG 1006.....		5		
GPKD 0806-03 EPNI.....5		5	GPKG 1008.....		5		
GPKD 1008-03 EPNI.....5		5					
ØD(Metric) - ØD2(Metric)		Bag Qty	ØD(Metric) - ØD2(Metric)		Bag Qty		
PKD 0604-G01 EPNI.....5		5	PKG 1/4-5/32.....		5		
PKD 0604-G02 EPNI.....5		5	PKG 5/16-1/4.....		5		
PKD 0804-G02 EPNI.....5		5					
PKD 0806-G02 EPNI.....5		5					
PKD 0806-G03 EPNI.....5		5					
PKD 1008-G03 EPNI.....5		5					
			PXG REDUCER DOUBLE Y 				
			PXG 1/4-5/32.....5 PXG 5/16-1/4.....5 ØD(Metric) - ØD2(Metric) Bag Qty GPXG 0604.....5 GPXG 0806.....5				

Model (ØD-R)

		ØD (Inch) - R (NPT)		Bag Qty		ØD (Metric) -R (BSPT)		Bag Qty		ØD (Metric) -R (NPT)		Bag Qty		
PCJ PLUG-IN MALE 		PCJ 5/32-N01 EPNI.....	10	GPCJ 0401 EPNI.....	10	PCJ 04-N01 EPNI.....	10			PCJ 04-N02 EPNI.....	10			
		PCJ 5/32-N02 EPNI.....	10	GPCJ 0402 EPNI.....	10	PCJ 04-U10 EPNI.....	10			PCJ 06-N01 EPNI.....	10			
		PCJ 5/32-U10 EPNI.....	10	GPCJ 04M5 EPNI.....	10	PCJ 3/16-N01 EPNI.....	10			PCJ 06-N02 EPNI.....	10			
		PCJ 3/16-N01 EPNI.....	10	GPCJ 0601 EPNI.....	10	PCJ 3/16-N02 EPNI.....	10			PCJ 06-N03 EPNI.....	10			
		PCJ 3/16-N02 EPNI.....	10	GPCJ 0602 EPNI.....	10	PCJ 3/16-U10 EPNI.....	10			PCJ 06-U10 EPNI.....	10			
		PCJ 3/16-U10 EPNI.....	10	GPCJ 0603 EPNI.....	10	PCJ 1/4-N01 EPNI.....	10			PCJ 08-N01 EPNI.....	10			
		PCJ 1/4-N01 EPNI.....	10	GPCJ 06M5 EPNI.....	10	PCJ 1/4-N02 EPNI.....	10			PCJ 08-N02 EPNI.....	10			
		PCJ 1/4-N02 EPNI.....	10	GPCJ 0801 EPNI.....	10	PCJ 1/4-N03 EPNI.....	10			PCJ 08-N03 EPNI.....	10			
		PCJ 1/4-N03 EPNI.....	10	GPCJ 0802 EPNI.....	10	PCJ 1/4-U10 EPNI.....	10			PCJ 10-N02 EPNI.....	5			
		PCJ 1/4-U10 EPNI.....	10	GPCJ 0803 EPNI.....	10	PCJ 5/16-N02 EPNI.....	10			PCJ 10-N03 EPNI.....	5			
		PCJ 5/16-N02 EPNI.....	10	GPCJ 1002 EPNI.....	5	PCJ 5/16-N03 EPNI.....	10			PCJ 10-N04 EPNI.....	5			
		PCJ 5/16-N03 EPNI.....	10	GPCJ 1003 EPNI.....	5	PCJ 3/8-N02 EPNI.....	5			PCJ 12-N02 EPNI.....	5			
		PCJ 3/8-N02 EPNI.....	5	GPCJ 1004 EPNI.....	5	PCJ 3/8-N03 EPNI.....	5			PCJ 12-N03 EPNI.....	5			
		PCJ 3/8-N03 EPNI.....	5	GPCJ 1202 EPNI.....	5	PCJ 3/8-N04 EPNI.....	5			PCJ 12-N04 EPNI.....	5			
		PCJ 3/8-N04 EPNI.....	5	GPCJ 1203 EPNI.....	5	PCJ 1/2-N02 EPNI.....	5							
		PCJ 1/2-N02 EPNI.....	5	GPCJ 1204 EPNI.....	5	PCJ 1/2-N03 EPNI.....	5							
		PCJ 1/2-N03 EPNI.....	5	GPCJ 1403 EPNI.....	4	PCJ 1/2-N04 EPNI.....	5							
		PCJ 1/2-N04 EPNI.....	5	GPCJ 1404 EPNI.....	4									
				GPCJ 1603 EPNI.....	4									
				GPCJ 1604 EPNI.....	4									





Model (ØD)



PLJ PLUG-IN ELBOW 		PLLJ PLUG-IN EXTENDED ELBOW 		PLJ45 PLUG-IN 45 ELBOW 		PLLJ45 PLUG-IN EXTENDED 45 ELBOW 									
ØD(Inch)	Bag Qty	ØD(Metric)	Bag Qty	ØD(Inch)	Bag Qty	ØD(Metric)	Bag Qty	ØD(Inch)	Bag Qty	ØD(Metric)	Bag Qty	ØD(Inch)	Bag Qty	ØD(Metric)	Bag Qty
PLJ 5/32.....	10	GPLJ 04.....	10	PLLJ 5/32.....	10	GPLLJ 04.....	10	PLJ45 5/32.....	10	GPLJ45 04.....	10	PLLJ45 5/32.....	10	GPLLJ45 04.....	10
PLJ 3/16.....	10	GPLJ 06.....	10	PLLJ 3/16.....	10	GPLLJ 06.....	10	PLJ45 3/16.....	10	GPLJ45 06.....	10	PLLJ45 3/16.....	10	GPLLJ45 06.....	10
PLJ 1/4.....	10	GPLJ 08.....	10	PLLJ 1/4.....	10	GPLLJ 08.....	10	PLJ45 1/4.....	10	GPLJ45 08.....	10	PLLJ45 1/4.....	10	GPLLJ45 08.....	10
PLJ 5/16.....	10	GPLJ 10.....	5	PLLJ 5/16.....	10	GPLLJ 10.....	5	PLJ45 5/16.....	10	GPLJ45 10.....	5	PLLJ45 5/16.....	10	GPLLJ45 10.....	5
PLJ 3/8.....	10	GPLJ 12.....	5	PLLJ 3/8.....	5	GPLLJ 12.....	5	PLJ45 3/8.....	10	GPLJ45 12.....	5	PLLJ45 3/8.....	5	GPLLJ45 12.....	5
PLJ 1/2.....	5	GPLJ 14.....	5	PLLJ 1/2.....	5	GPLLJ 14.....	5	PLJ45 1/2.....	5			PLLJ45 1/2.....	5		
		GPLJ 16.....	5			GPLLJ 16.....	5								

Model (ØD)



Model (ØD-ØD2)



Model (ØD)

PYJ PLUG-IN Y 		PIJ TUBE SPLICER 		PIG REDUCER TUBE SPLICER 		PJH PLUG-IN BARB 							
ØD(Inch)	Bag Qty	ØD(Metric)	Bag Qty	ØD(Inch)	Bag Qty	ØD - ØD2(Inch)	Bag Qty	ØD - ØD2(Metric)	Bag Qty	ØD (Inch) Barb	Bag Qty	ØD (Metric) Barb	Bag Qty
PYJ 5/32.....	10	GPYJ 04.....	10	PIJ 5/32.....	10	PIG 3/16-5/32.....	10	PIG 0604.....	10	PJH 04-1/8.....	10	PJH 0404.....	10
PYJ 3/16.....	10	GPYJ 06.....	10	PIJ 3/16.....	10	PIG 1/4-5/32.....	10	PIG 0804.....	10	PJH 08-1/4.....	10	PJH 0405.....	10
PYJ 1/4.....	10	GPYJ 08.....	10	PIJ 1/4.....	10	PIG 1/4-3/16.....	10	PIG 0806.....	10	PJH 10-1/4.....	10	PJH 0605.....	10
PYJ 5/16.....	10	GPYJ 10.....	5	PIJ 5/16.....	10	PIG 5/16-5/32.....	10	PIG 1006.....	10	PJH 12-1/2.....	10	PJH 0606.....	10
PYJ 3/8.....	5	GPYJ 12.....	5	PIJ 3/8.....	10	PIG 3/8-1/4.....	10	PIG 1008.....	10	PJH 14-1/2.....	10	PJH 0806.....	10
PYJ 1/2.....	5			PIJ 1/2.....	10	PIG 3/8-1/4.....	10	PIG 1208.....	10			PJH 0808.....	10
						PIG 5/16-1/4.....	10	PIG 1008.....	10			PJH 1008.....	10
						PIG 1/2-5/16.....	10	PIG 1210.....	10			PJH 1208.....	10
						PIG 1/2-3/8.....	10	PIG 1612.....	10			PJH 1210.....	10
												PJH 1213.....	10
												PJH 1414.....	10

Model (ØD-ØD2)					
ØD - ØD2(Inch)		Bag Qty	ØD - ØD2(Inch)		Bag Qty
PGJ PLUG-IN REDUCER 	PGJ 1/4-5/32.....10		PLGJ PLUG-IN REDUCER ELBOW 	PLGJ 3/16-5/32.....10	
	PGJ 5/16-5/32.....10			PLGJ 1/4-5/32.....10	
PGJ 5/16-1/4.....10	PLGJ 1/4-3/16.....10				
PGJ 3/8-1/4.....10	PLGJ 5/16-1/4.....10				
PGJ 3/8-5/16.....10	PLGJ 3/8-5/16.....5				
PGJ 1/2-1/4.....5	PLGJ 1/2-3/8.....5				
PGJ 1/2-5/16.....5					
PGJ 1/2-3/8.....5					
ØD - ØD2(Metric) Bag Qty			ØD - ØD2(Metric) Bag Qty		
GPGJ 0604.....10			GPLGJ 0604.....10		
GPGJ 0804.....10		GPLGJ 0806.....10			
GPGJ 0806.....10		GPLGJ 1008.....10			
GPGJ 1006.....10		GPLGJ 1210.....5			
GPGJ 1008.....10					
GPGJ 1206.....5					
GPGJ 1208.....5					
GPGJ 1210.....5					
GPGJ 1412.....5					
		ØD - ØD2(Metric) Bag Qty			
		GPLGJ45 0604.....10 GPLGJ45 0806.....10 GPLGJ45 1008.....5 GPLGJ45 1210.....5			

Model (ØD-ØD2)			Model (ØD)		
ØD - ØD2(Inch)		Bag Qty	ØD (Inch)		Bag Qty
PWJ PLUG-IN REDUCER Y 	PWJ 1/4-5/32.....10		PKJ PLUG-IN REDUCER TRIPLE BRANCH 	PKJ 3/16-5/32.....5	
	PWJ 5/16-1/4.....10			PKJ 1/4-5/32.....5	
PWJ 3/8-5/16.....10	PKJ 5/16-5/32.....5				
PWJ 1/2-3/8.....10	PKJ 5/16-3/16.....5				
ØD - ØD2(Metric) Bag Qty			ØD (Metric) Bag Qty		
GPWJ 0604.....10			GPKJ 0604.....5		
GPWJ 0806.....10			GPKJ 0804.....5		
GPWJ 1008.....10			GPKJ 0806.....5		
GPWJ 1210.....5		GPKJ 1006.....5			
		GPKJ 1008.....5			

Model (ØD-ØD2)			Model (ØD)		
ØD - ØD2(Inch)		Bag Qty	ØD(Metric)		Bag Qty
PXJ PLUG-IN REDUCER DOUBLE Y 	PXJ 1/4-5/32.....5		PCP ACE COUPLER PLUG 	GPCP 04 EPNI.....10	
	PXJ 5/16-1/4.....5			GPCP 06 EPNI.....10	
ØD - ØD2(Metric) Bag Qty			ØD(Inch) Bag Qty		
GPXJ 0604.....5			PP 5/32.....10		
GPXJ 0806.....5		PP 3/16.....10			
		ØD(Metric) Bag Qty			
		PP 04.....10 PP 06.....10 PP 08.....10 PP 10.....10 PP 12.....10 PP 14.....10 PP 16.....5			

Model (ØD)					
ØD(Inch)		Bag Qty	ØD(Inch)		Bag Qty
PPF CAP 	PPF 5/32.....10		CAS INSERT TUBE 	CAS-N5/32.....10	
	PPF 3/16.....10			CAS-N1/4.....10	
PPF 1/4.....10	CAS-N5/16.....10				
PPF 5/16.....10	CAS-N3/8.....10				
PPF 3/8.....10	CAS-N1/2.....10				
PPF 1/2.....10					
ØD(Metric) Bag Qty		ØD(Metric) Bag Qty			
GPPF 04.....10		CAS-N04.....10			
GPPF 06.....10		CAS-N06.....10			
GPPF 08.....10		CAS-N08.....10			
GPPF 10.....10		CAS-N10.....10			
GPPF 12.....10		CAS-N12.....10			
		ØD(Metric) Bag Qty			
		CASI-N04.....10 CASI-N06.....10 CASI-N08.....10 CASI-N10.....10 CASI-N12.....10			

COMPACT ONE TOUCH FITTINGS

Application:

- Compact one-touch fittings useful for confined spaces
- Wide variety of models available to meet all needs



Features:

- The world's smallest quick-fitting joints feature 40% smaller volume ratio
- and 20% smaller O.D. ratio in comparison to conventional type
- Elliptical sleeve allows easy connect/disconnect by one touch
- Fittings include NBR O-ring and Teflon treated threads

STRUCTURAL DIAGRAM

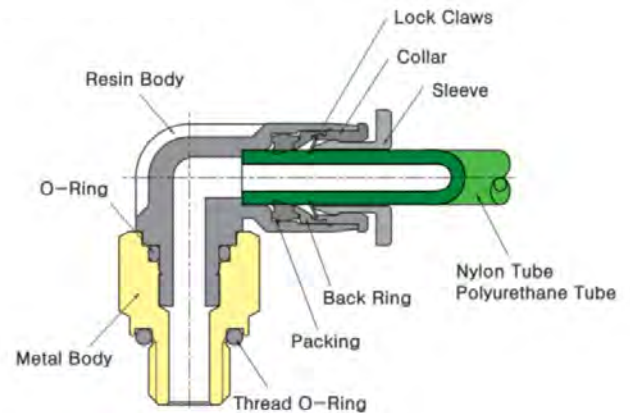



Specifications		
Fluid	AIR (No other gases or liquids)	
Working Pressure Range	0 ~ 150 psi	0 ~ 1034 kPa
Negative Pressure	-14.5 psi	-100 kPa
Temperature Range	32 ~ 140F	0 ~ 60C
Applicable Tubing	Polyurethane and Nylon	

Model (ØD-R)

	ØD (Inch) - R (NPT) Bag Qty	ØD (Inch) - R (BSPT) Bag Qty	ØD (Metric) - R (BSPT) Bag Qty	ØD (Metric) - R (BSPP) Bag Qty
PC-C MALE STRAIGHT 	PC 1/8-U10C10	PC 1/8-M3C10	PC 03M3C(1.2).....10	PC 04G01C(3.0).....10
	PC 1/8-N1/16C10	PC 1/8-M5C10	PC 03M5C(2.0).....10	PC 06G01C(4.5).....10
	PC 1/8-N01C10	PC 1/8-M6C10	PC 03M6C(2.0).....10	
	PC 5/32-U10C10	PC 5/32-M3C10	PC 04M3C(1.2).....10	
	PC 5/32-N1/16C10	PC 5/32-M5C10	PC 04M5C(2.0).....10	
	PC 5/32-N01C10	PC 5/32-M6C10	PC 04M6C(3.0).....10	
	PC 1/4-U10C10	PC 5/32-01C10	PC 0401C(3.0).....10	
	PC 1/4-N1/16C10	PC 1/4-M5C10	PC 06M5C(2.0).....10	
	PC 1/4-N01C10	PC 1/4-M6C10	PC 06M6C(3.0).....10	
		PC 1/4-01C10	PC 0601C(4.5).....10	

Model (ØD-R)

	ØD (Inch) - R (NPT) Bag Qty	ØD (Inch) - R (BSPT) Bag Qty	ØD (Metric) - R (BSPT) Bag Qty	ØD (Metric) - R (BSPP) Bag Qty
POC-C ROUND MALE STRAIGHT 	POC 1/8-U10C10	POC 1/8-M3C10	POC 03M3C(H1.5)10	POC 04G01C(H3.0)10
	POC 1/8-N1/16C10	POC 1/8-M5C10	POC 03M5C(H2.0)10	POC 06G01C(H4.0)10
	POC 1/8-N01C10	POC 1/8-M6C10	POC 03M6C(H2.0)10	
	POC 5/32-U10C10	POC 5/32-M3C10	POC 04M3C(H1.5)10	
	POC 5/32-N1/16C10	POC 5/32-M5C10	POC 04M5C(H2.5)10	
	POC 5/32-N01C10	POC 5/32-M6C10	POC 04M6C(H3.0)10	
	POC 1/4-U10C10	POC 5/32-01C10	POC 0401C(H3.0)10	
	POC 1/4-N1/16C10	POC 1/4-M5C10	POC 06M5C(H2.5)10	
	POC 1/4-N01C10	POC 1/4-M6C10	POC 06M6C(H3.0)10	
		POC 1/4-01C10	POC 0601C(H4.0)10	

Model (ØD-R)				
	ØD (Inch) - R (NPT) Bag Qty	ØD (Inch) - R (BSPT) Bag Qty	ØD (Metric) - R (BSPT) Bag Qty	
PCF-C FEMALE STRAIGHT 	PCF 1/8-U10C.....10	PCF 1/8-M3C.....10	PCF 03M3C.....10	
	PCF 1/8-N1/16C.....10	PCF 1/8-M5C.....10	PCF 03M5C.....10	
	PCF 5/32-U10C.....10	PCF 5/32-M3C.....10	PCF 04M3C.....10	
	PCF 5/32-N1/16C.....10	PCF 5/32-M5C.....10	PCF 04M5C.....10	

Model (ØD-R)				
	ØD (Inch) - R (NPT) Bag Qty	ØD (Inch) - R (BSPT) Bag Qty	ØD (Metric) - R (BSPT) Bag Qty	ØD (Metric) - R (BSPP) Bag Qty
PL-C MALE ELBOW 	PL 1/8-N01C.....10	PL 1/8-M3C.....10	PL 03M3C(1.2).....10	PL 04G01C(4.8).....10
	PL 1/8-N1/16C.....10	PL 1/8-M5C.....10	PL 03M5C(2.0).....10	PL 06G01C(4.8).....10
	PL 1/8-U10C.....10	PL 1/8-M6C.....10	PL 03M6C(3.0).....10	
	PL 5/32-N01C.....10	PL 5/32-01C.....10	PL 04M3C(1.2).....10	
	PL 5/32-U10C.....10	PL 5/32-M3C.....10	PL 04M5C(2.0).....10	
	PL 5/32-N1/16C.....10	PL 5/32-M5C.....10	PL 04M6C(3.0).....10	
	PL 1/4-N01C.....10	PL 5/32-M6C.....10	PL 0401C(4.8).....10	
	PL 1/4-N1/16C.....10	PL 1/4-01C.....10	PL 06M5C(2.0).....10	
	PL 1/4-U10C.....10	PL 1/4-M5C.....10	PL 06M6C(3.0).....10	
		PL 1/4-M6C.....10	PL 0601C(4.8).....10	

Model (ØD-R)				
	ØD (Inch) - R (NPT) Bag Qty	ØD (Inch) - R (BSPT) Bag Qty	ØD (Metric) - R (BSPT) Bag Qty	ØD (Metric) - R (BSPP) Bag Qty
PLL-C EXTENDED MALE ELBOW 	PLL 1/8-U10C.....10	PLL 1/8-M3C.....10	PLL 03M3C(1.2).....10	PLL 04G01C(4.8).....10
	PLL 1/8-N1/16C.....10	PLL 1/8-M5C.....10	PLL 03M5C(2.0).....10	PLL 06G01C(4.8).....10
	PLL 1/8-N01C.....10	PLL 5/32-M3C.....10	PLL 04M3C(1.2).....10	
	PLL 5/32-U10C.....10	PLL 5/32-M5C.....10	PLL 04M5C(2.0).....10	
	PLL 5/32-N1/16C.....10	PLL 5/32-M6C.....10	PLL 04M6C(3.0).....10	
	PLL 5/32-N01C.....10	PLL 5/32-01C.....10	PLL 0401C(4.8).....10	
	PLL 1/4-U10C.....10	PLL 1/4-M5C.....10	PLL 06M5C(2.0).....10	
	PLL 1/4-N1/16C.....10	PLL 1/4-M6C.....10	PLL 06M6C(3.0).....10	
	PLL 1/4-N01C.....10	PLL 1/4-01C.....10	PLL 0601C(4.8).....10	

Model (ØD-R)				
	ØD (Inch) - R (NPT) Bag Qty	ØD (Inch) - R (BSPT) Bag Qty	ØD (Metric) - R (BSPT) Bag Qty	ØD (Metric) - R (BSPP) Bag Qty
PT-C MALE BRANCH TEE 	PT 1/8-U10C.....10	PT 1/8-M3C.....10	PT 03M3C(1.2).....10	PT 04G01C(4.8).....10
	PT 1/8-N1/16C.....10	PT 1/8-M5C.....10	PT 03M5C(2.0).....10	PT 06G01C(4.8).....10
	PT 1/8-N01C.....10	PT 1/8-M6C.....10	PT 03M6C(3.0).....10	
	PT 5/32-U10C.....10	PT 5/32-M3C.....10	PT 04M3C(1.2).....10	
	PT 5/32-N1/16C.....10	PT 5/32-M5C.....10	PT 04M5C(2.0).....10	
	PT 5/32-N01C.....10	PT 5/32-M6C.....10	PT 04M6C(3.0).....10	
	PT 1/4-U10C.....10	PT 5/32-01C.....10	PT 0401C(4.8).....10	
	PT 1/4-N1/16C.....10	PT 1/4-M5C.....10	PT 06M5C(2.0).....10	
	PT 1/4-N01C.....10	PT 1/4-M6C.....10	PT 06M6C(3.0).....10	
		PT 1/4-01C.....10	PT 0601C(4.8).....10	

Model (ØD-R)				
	ØD (Inch) - R (NPT) Bag Qty	ØD (Inch) - R (BSPT) Bag Qty	ØD (Metric) - R (BSPT) Bag Qty	ØD (Metric) - R (BSPP) Bag Qty
PST-C MALE RUN TEE 	PST 1/8-N01C.....10	PST 1/8-M3C.....10	PST 03M3C(1.2).....10	PST 04G01C(4.8).....10
	PST 1/8-N1/16C.....10	PST 1/8-M5C.....10	PST 03M5C(2.0).....10	PST 06G01C(4.8).....10
	PST 1/8-U10C.....10	PST 1/8-M6C.....10	PST 03M6C(3.0).....10	
	PST 5/32-N01C.....10	PST 5/32-M3C.....10	PST 04M3C(1.2).....10	
	PST 5/32-N1/16C.....10	PST 5/32-M5C.....10	PST 04M5C(2.0).....10	
	PST 5/32-U10C.....10	PST 5/32-M6C.....10	PST 04M6C(3.0).....10	
	PST 1/4-N01C.....10	PST 5/32-01C.....10	PST 0401C(4.8).....10	
	PST 1/4-N1/16C.....10	PST 1/4-M5C.....10	PST 06M5C(2.0).....10	
	PST 1/4-U10C.....10	PST 1/4-M6C.....10	PST 06M6C(3.0).....10	
		PST 1/4-01C.....10	PST 0601C(4.8).....10	

Model (ØD)	Model (ØD)	Model (ØD)	Model (ØD)
PUC-C UNION STRAIGHT	PUL-C UNION ELBOW	PUT-C UNION TEE	PY-C UNION Y
			
ØD (Inch) Bag Qty	ØD (Inch) Bag Qty	ØD (Inch) Bag Qty	ØD (Inch) Bag Qty
PUC 1/8C10 PUC 5/32C10 PUC 1/4C10	PUL 1/8C10 PUL 5/32C10 PUL 1/4C10	PUT 1/8C10 PUT 5/32C10 PUT 1/4C10	PY 1/8C10 PY 5/32C10 PY 1/4C10
ØD (Metric) Bag Qty	ØD (Metric) Bag Qty	ØD (Metric) Bag Qty	ØD (Metric) Bag Qty
PUC 03C10 PUC 04C10 PUC 06C10	PUL 03C10 PUL 04C10 PUL 06C10	PUT 03C10 PUT 04C10 PUT 06C10	PY 03C10 PY 04C10 PY 06C10
PG-C REDUCER	PLJ-C PLUG-IN ELBOW	PZA-C UNION CROSS	PW-C REDUCER Y
			
ØD(Inch) - ØD2(Inch) Bag Qty	ØD (Inch) Bag Qty	ØD (Inch) Bag Qty	ØD(Inch) - ØD2(Inch) Bag Qty
PG 5/32-1/8C10	PLJ 1/8C10 PLJ 5/32C10 PLJ 1/4C10	PZA 1/8C10 PZA 5/32C10 PZA 1/4C10	PW 5/32-1/8C10 PW 1/4-5/32C10
ØD(Metric) - ØD2(Metric) Bag Qty	ØD (Metric) Bag Qty	ØD (Metric) Bag Qty	ØD(Metric) - ØD2(Metric) Bag Qty
PG 0403C10 PG 0604C10	PLJ 03C10 PLJ 04C10 PLJ 06C10	PZA 03C10 PZA 04C10 PZA 06C10	PW 0403C10 PW 0604C10
PMM-C BULKHEAD UNION	PLM-C BULKHEAD UNION ELBOW	PYJ-C PLUG-IN Y	PWJ-C PLUG-IN REDUCER Y
			
ØD (Inch) Bag Qty	ØD (Metric) Bag Qty	ØD (Inch) Bag Qty	ØD(Inch) - ØD2(Inch) Bag Qty
PMM 1/8C10 PMM 5/32C10	PLM 03C10 PLM 04C10 PLM 06C10	PYJ 1/8C10 PYJ 5/32C10 PYJ 1/4C10	PWJ 5/32-1/8C10 PWJ 1/4-5/32C10
ØD (Metric) Bag Qty		ØD (Metric) Bag Qty	ØD(Metric) - ØD2(Metric) Bag Qty
PMM 03C10 PMM 04C10 PMM 06C10		PYJ 03C10 PYJ 04C10 PYJ 06C10	PWJ 0403C10 PWJ 0604C10
PGJ-C PLUG-IN REDUCER	PP-C PLUG	PPF-C CAP	PCC-C ROUND MALE STRAIGHT
			
ØD(Inch) - ØD2(Inch) Bag Qty	ØD (Inch) Bag Qty	ØD (Inch) Bag Qty	ØD (Inch) - R (BSPT) Bag Qty
PGJ 1/4-5/32C10	PP 1/8C10 PP 1/4C10	PPF 1/8C10 PPF 5/32C10 PPF 1/4C10	PCC 1/8-M6C10
ØD(Metric) - ØD2(Metric) Bag Qty	ØD (Metric) Bag Qty	ØD (Metric) Bag Qty	ØD (Metric) - R (Metric) Bag Qty
PGJ 0403C10 PGJ 0604C10	PP 03C10	PPF 03C10 PPF 04C10 PPF 06C10	PCC 03M6C(H2.0)10 PCC 04M6C(H2.5)10 PCC 04M8C(H3.0)10 PCC 06M8C(H4.0)10

*PCC ONLY: M6X0.75, M8X0.75

Metallic One Touch Fittings

APPLICATION:

- One-touch fittings used for piping Air or select Fluids
- Not suitable for potable water systems

FEATURES:

- Easy to connect/disconnect tube by one touch
- Nickel plated brass construction
- Fittings include NBR O-ring and Teflon treated threads



Specifications		
Fluid	AIR or Select Fluids	
Working Pressure Range	0 ~ 290 psi	0 ~ 1999 kPa
Negative Pressure	-14.5 psi	-100 kPa
Temperature Range	-4 ~ 176F	-20 ~ 80C
Applicable Tubing	Polyurethane and Nylon	

*SPECIFICATIONS APPLY FOR AIR ONLY

	Model (ØD-R)			
	ØD (Inch) - R (NPT) Bag Qty	ØD (Inch) - R (BSPP) Bag Qty	ØD (Metric) - R (BSPT) Bag Qty	ØD (Metric) - R (BSPP) Bag Qty
MPC MALE STRAIGHT 	MPC 5/32-N1/8.....10	MPC 5/32-G1/8.....10	MPC 04-M5.....10	MPC 04-G01.....10
	MPC 5/32-N1/4.....10	MPC 5/32-G1/4.....10	MPC 04-01.....10	MPC 04-G02.....10
	MPC 1/4-N1/8.....10	MPC 1/4-G1/8.....10	MPC 04-02.....10	MPC 06-G01.....10
	MPC 1/4-N1/4.....10	MPC 1/4-G1/4.....10	MPC 06-M5.....10	MPC 06-G02.....10
	MPC 1/4-N3/8.....10	MPC 1/4-G3/8.....10	MPC 06-01.....10	MPC 06-G03.....10
	MPC 1/4-N1/2.....10	MPC 1/4-G1/2.....10	MPC 06-02.....10	MPC 06-G04.....10
	MPC 5/16-N1/8.....10	MPC 5/16-G1/8.....10	MPC 06-03.....10	MPC 08-G01.....10
	MPC 5/16-N1/4.....10	MPC 5/16-G1/4.....10	MPC 06-04.....10	MPC 08-G02.....10
	MPC 5/16-N3/8.....10	MPC 5/16-G3/8.....10	MPC 08-01.....10	MPC 08-G03.....10
	MPC 5/16-N1/2.....10	MPC 5/16-G1/2.....10	MPC 08-02.....10	MPC 08-G04.....10
	MPC 3/8-N1/8.....10	MPC 3/8-G1/8.....10	MPC 08-03.....10	MPC 10-G01.....10
	MPC 3/8-N1/4.....10	MPC 3/8-G1/4.....10	MPC 08-04.....10	MPC 10-G02.....10
	MPC 3/8-N3/8.....10	MPC 3/8-G3/8.....10	MPC 10-01.....10	MPC 10-G03.....10
	MPC 3/8-N1/2.....10	MPC 3/8-G1/2.....10	MPC 10-02.....10	MPC 10-G04.....10
	MPC 1/2-N1/8.....10	MPC 1/2-G1/8.....10	MPC 10-03.....10	MPC 12-G01.....10
	MPC 1/2-N1/4.....10	MPC 1/2-G1/4.....10	MPC 10-04.....10	MPC 12-G02.....10
	MPC 1/2-N3/8.....10	MPC 1/2-G3/8.....10	MPC 12-01.....10	MPC 12-G03.....10
	MPC 1/2-N1/2.....5	MPC 1/2-G1/2.....5	MPC 12-02.....10	MPC 12-G04.....5
			MPC 12-03.....10	MPC 14-G03.....5
			MPC 12-04.....5	MPC 14-G04.....5
			MPC 14-03.....5	MPC 16-G03.....5
			MPC 14-04.....5	MPC 16-G04.....5
		MPC 16-03.....5		
		MPC 16-04.....5		

Model (ØD-R)

	ØD (Inch) - R (NPT)	Bag Qty	ØD (Inch) - R (BSPP)	Bag Qty	ØD (Metric) - R (BSPT)	Bag Qty	ØD (Metric) - R (BSPP)	Bag Qty
MPCF FEMALE STRAIGHT 	MPCF 5/32-N1/8	10	MPCF 5/32-G1/8	10	MPCF 04-M5	10	MPCF 04-G01	10
	MPCF 5/32-N1/4	10	MPCF 5/32-G1/4	10	MPCF 04-01	10	MPCF 04-G02	10
	MPCF 1/4-N1/8	10	MPCF 1/4-G1/8	10	MPCF 04-02	10	MPCF 06-G01	10
	MPCF 1/4-N1/4	10	MPCF 1/4-G1/4	10	MPCF 06-M5	10	MPCF 06-G02	10
	MPCF 1/4-N3/8	10	MPCF 1/4-G3/8	10	MPCF 06-01	10	MPCF 06-G03	10
	MPCF 1/4-N1/2	10	MPCF 1/4-G1/2	10	MPCF 06-02	10	MPCF 06-G04	10
	MPCF 5/16-N1/8	10	MPCF 5/16-G1/8	10	MPCF 06-03	10	MPCF 08-G01	10
	MPCF 5/16-N1/4	10	MPCF 5/16-G1/4	10	MPCF 06-04	10	MPCF 08-G02	10
	MPCF 5/16-N3/8	10	MPCF 5/16-G3/8	10	MPCF 08-01	10	MPCF 08-G03	10
	MPCF 5/16-N1/2	10	MPCF 5/16-G1/2	10	MPCF 08-02	10	MPCF 08-G04	10
	MPCF 3/8-N1/8	10	MPCF 3/8-G1/8	10	MPCF 08-03	10	MPCF 10-G01	10
	MPCF 3/8-N1/4	10	MPCF 3/8-G1/4	10	MPCF 08-04	10	MPCF 10-G02	10
	MPCF 3/8-N3/8	10	MPCF 3/8-G3/8	10	MPCF 10-01	10	MPCF 10-G03	10
	MPCF 3/8-N1/2	10	MPCF 3/8-G1/2	10	MPCF 10-02	10	MPCF 10-G04	10
	MPCF 1/2-N1/8	10	MPCF 1/2-G1/8	10	MPCF 10-03	10	MPCF 12-G01	10
	MPCF 1/2-N1/4	10	MPCF 1/2-G1/4	10	MPCF 10-04	10	MPCF 12-G02	10
	MPCF 1/2-N3/8	10	MPCF 1/2-G3/8	10	MPCF 12-01	10	MPCF 12-G03	10
	MPCF 1/2-N1/2	5	MPCF 1/2-G1/2	5	MPCF 12-02	10	MPCF 12-G04	5
					MPCF 12-03	10	MPCF 14-G03	5
					MPCF 12-04	5	MPCF 14-G04	5
				MPCF 14-03	5	MPCF 16-G03	5	
				MPCF 14-04	5	MPCF 16-G04	5	
				MPCF 16-03	5			
				MPCF 16-04	5			

Model (ØD-R)

	ØD (Inch) - R (NPT)	Bag Qty	ØD (Inch) - R (BSPP)	Bag Qty	ØD (Metric) - R (BSPT)	Bag Qty	ØD (Metric) - R (BSPP)	Bag Qty
MPL MALE ELBOW 	MPL 5/32-N1/8	10	MPL 5/32-G1/8	10	MPL 04-M5	10	MPL 04-G01	10
	MPL 5/32-N1/4	10	MPL 5/32-G1/4	10	MPL 04-01	10	MPL 04-G02	10
	MPL 1/4-N1/8	10	MPL 1/4-G1/8	10	MPL 04-02	10	MPL 06-G01	10
	MPL 1/4-N1/4	10	MPL 1/4-G1/4	10	MPL 06-M5	10	MPL 06-G02	10
	MPL 1/4-N3/8	10	MPL 1/4-G3/8	10	MPL 06-01	10	MPL 06-G03	10
	MPL 1/4-N1/2	10	MPL 1/4-G1/2	10	MPL 06-02	10	MPL 06-G04	5
	MPL 5/16-N1/8	10	MPL 5/16-G1/8	10	MPL 06-03	10	MPL 08-G01	10
	MPL 5/16-N1/4	10	MPL 5/16-G1/4	10	MPL 06-04	5	MPL 08-G02	10
	MPL 5/16-N3/8	10	MPL 5/16-G3/8	10	MPL 08-01	10	MPL 08-G03	10
	MPL 5/16-N1/2	5	MPL 5/16-G1/2	5	MPL 08-02	10	MPL 08-G04	5
	MPL 3/8-N1/8	10	MPL 3/8-G1/8	10	MPL 08-03	10	MPL 10-G01	10
	MPL 3/8-N1/4	5	MPL 3/8-G1/4	5	MPL 08-04	5	MPL 10-G02	10
	MPL 3/8-N3/8	5	MPL 3/8-G3/8	5	MPL 10-01	10	MPL 10-G03	10
	MPL 3/8-N1/2	5	MPL 3/8-G1/2	5	MPL 10-02	10	MPL 10-G04	5
	MPL 1/2-N1/8	5	MPL 1/2-G1/8	5	MPL 10-03	10	MPL 12-G01	5
	MPL 1/2-N1/4	5	MPL 1/2-G1/4	5	MPL 10-04	5	MPL 12-G02	5
	MPL 1/2-N3/8	5	MPL 1/2-G3/8	5	MPL 12-01	5	MPL 12-G03	5
	MPL 1/2-N1/2	5	MPL 1/2-G1/2	5	MPL 12-02	5	MPL 12-G04	5
					MPL 12-03	5	MPL 14-G03	5
					MPL 12-04	5	MPL 14-G04	5
				MPL 14-03	5	MPL 16-G03	5	
				MPL 14-04	5	MPL 16-G04	5	
				MPL 16-03	5			
				MPL 16-04	5			

Model (ØD-R)

	ØD (Inch) - R (NPT)	Bag Qty	ØD (Inch) - R (BSPP)	Bag Qty	ØD (Metric) - R (BSPT)	Bag Qty	ØD (Metric) - R (BSPP)	Bag Qty
MPH MALE BANJO 	MPH 5/32-N1/8	10	MPH 5/32-G1/8	10	MPH 04-01	10	MPH 04-G01	10
	MPH 5/32-N1/4	10	MPH 5/32-G1/4	10	MPH 04-02	10	MPH 04-G02	10
	MPH 1/4-N1/8	10	MPH 1/4-G1/8	10	MPH 06-M5	10	MPH 06-G01	10
	MPH 1/4-N1/4	10	MPH 1/4-G1/4	10	MPH 06-01	10	MPH 06-G02	10
	MPH 1/4-N3/8	10	MPH 1/4-G3/8	10	MPH 06-02	10	MPH 06-G03	10
	MPH 1/4-N1/2	10	MPH 1/4-G1/2	10	MPH 06-03	10	MPH 06-G04	5
	MPH 5/16-N1/8	10	MPH 5/16-G1/8	10	MPH 06-04	5	MPH 08-G01	10
	MPH 5/16-N1/4	10	MPH 5/16-G1/4	10	MPH 08-01	10	MPH 08-G02	10
	MPH 5/16-N3/8	5	MPH 5/16-G3/8	5	MPH 08-02	10	MPH 08-G03	10
	MPH 5/16-N1/2	5	MPH 5/16-G1/2	5	MPH 08-03	10	MPH 08-G04	5
	MPH 3/8-N1/8	5	MPH 3/8-G1/8	5	MPH 08-04	5	MPH 10-G01	5
	MPH 3/8-N1/4	5	MPH 3/8-G1/4	5	MPH 10-01	5	MPH 10-G02	5
	MPH 3/8-N3/8	5	MPH 3/8-G3/8	5	MPH 10-02	5	MPH 10-G03	5
	MPH 3/8-N1/2	5	MPH 3/8-G1/2	5	MPH 10-03	5	MPH 10-G04	5
	MPH 1/2-N1/4	5	MPH 1/2-G1/4	5	MPH 10-04	5	MPH 12-G02	5
	MPH 1/2-N3/8	5	MPH 1/2-G3/8	5	MPH 12-01	5	MPH 12-G03	5
	MPH 1/2-N1/2	5	MPH 1/2-G1/2	5	MPH 12-02	5	MPH 12-G04	5
					MPH 12-03	5		
					MPH 12-04	5		





Model (ØD-R)				
	ØD (Inch) - R (NPT) Bag Qty	ØD (Inch) - R (BSPP) Bag Qty	ØD (Metric) - R (BSPT) Bag Qty	ØD (Metric) -R (BSPP) Bag Qty
MNSE SPEED CONTROLLER ELBOW 	MPH 5/32-N1/8.....10	MPH 5/32-G1/8.....10	MPH 04-01.....10	MPH 04-G01.....10
	MPH 5/32-N1/4.....10	MPH 5/32-G1/4.....10	MPH 04-02.....10	MPH 04-G02.....10
	MPH 1/4-N1/8.....10	MPH 1/4-G1/8.....10	MPH 06-M5.....10	MPH 06-G01.....10
	MPH 1/4-N1/4.....10	MPH 1/4-G1/4.....10	MPH 06-01.....10	MPH 06-G02.....10
	MPH 1/4-N3/8.....10	MPH 1/4-G3/8.....10	MPH 06-02.....10	MPH 06-G03.....10
	MPH 1/4-N1/2.....10	MPH 1/4-G1/2.....10	MPH 06-03.....10	MPH 06-G04.....5
	MPH 5/16-N1/8.....10	MPH 5/16-G1/8.....10	MPH 06-04.....5	MPH 08-G01.....10
	MPH 5/16-N1/4.....10	MPH 5/16-G1/4.....10	MPH 08-01.....10	MPH 08-G02.....10
	MPH 5/16-N3/8.....5	MPH 5/16-G3/8.....5	MPH 08-02.....10	MPH 08-G03.....10
	MPH 5/16-N1/2.....5	MPH 5/16-G1/2.....5	MPH 08-03.....10	MPH 08-G04.....5
	MPH 3/8-N1/8.....5	MPH 3/8-G1/8.....5	MPH 08-04.....5	MPH 10-G01.....5
	MPH 3/8-N1/4.....5	MPH 3/8-G1/4.....5	MPH 10-01.....5	MPH 10-G02.....5
	MPH 3/8-N3/8.....5	MPH 3/8-G3/8.....5	MPH 10-02.....5	MPH 10-G03.....5
	MPH 3/8-N1/2.....5	MPH 3/8-G1/2.....5	MPH 10-03.....5	MPH 10-G04.....5
	MPH 1/2-N1/4.....5	MPH 1/2-G1/4.....5	MPH 10-04.....5	MPH 12-G02.....5
	MPH 1/2-N3/8.....5	MPH 1/2-G3/8.....5	MPH 12-02.....5	MPH 12-G03.....5
	MPH 1/2-N1/2.....5	MPH 1/2-G1/2.....5	MPH 12-03.....5	MPH 12-G04.....5
			MPH 12-04.....5	

Model (ØD-R)				
	ØD (Inch) - R (NPT) Bag Qty	ØD (Inch) - R (BSPP) Bag Qty	ØD (Metric) - R (BSPT) Bag Qty	ØD (Metric) -R (BSPP) Bag Qty
MPT MALE BRANCH TEE 	MPT 5/32-N1/8.....10	MPT 5/32-G1/8.....10	MPT 04-M5.....10	MPT 04-G01.....10
	MPT 5/32-N1/4.....10	MPT 5/32-G1/4.....10	MPT 04-01.....10	MPT 04-G02.....10
	MPT 1/4-N1/8.....10	MPT 1/4-G1/8.....10	MPT 04-02.....10	MPT 06-G01.....10
	MPT 1/4-N1/4.....10	MPT 1/4-G1/4.....10	MPT 06-M5.....10	MPT 06-G02.....10
	MPT 1/4-N3/8.....10	MPT 1/4-G3/8.....10	MPT 06-01.....10	MPT 06-G03.....10
	MPT 1/4-N1/2.....10	MPT 1/4-G1/2.....10	MPT 06-02.....10	MPT 06-G04.....5
	MPT 5/16-N1/4.....10	MPT 5/16-G1/4.....10	MPT 06-03.....10	MPT 08-G01.....10
	MPT 5/16-N3/8.....5	MPT 5/16-G3/8.....5	MPT 06-04.....5	MPT 08-G02.....10
	MPT 5/16-N1/2.....5	MPT 5/16-G1/2.....5	MPT 08-01.....10	MPT 08-G03.....10
	MPT 3/8-N1/8.....5	MPT 3/8-G1/8.....5	MPT 08-02.....10	MPT 08-G04.....5
	MPT 3/8-N1/4.....5	MPT 3/8-G1/4.....5	MPT 08-03.....10	MPT 10-G01.....5
	MPT 3/8-N3/8.....5	MPT 3/8-G3/8.....5	MPT 08-04.....5	MPT 10-G02.....5
	MPT 3/8-N1/2.....5	MPT 3/8-G1/2.....5	MPT 10-01.....5	MPT 10-G03.....5
	MPT 1/2-N1/8.....5	MPT 1/2-G1/8.....5	MPT 10-02.....5	MPT 10-G04.....5
	MPT 1/2-N1/4.....5	MPT 1/2-G1/4.....5	MPT 10-03.....5	MPT 12-G01.....5
	MPT 1/2-N3/8.....5	MPT 1/2-G3/8.....5	MPT 10-04.....5	MPT 12-G02.....5
	MPT 1/2-N1/2.....5	MPT 1/2-G1/2.....5	MPT 12-01.....5	MPT 12-G03.....5
			MPT 12-02.....5	MPT 12-G04.....5
			MPT 12-03.....5	MPT 14-G03.....4
			MPT 12-04.....5	MPT 14-G04.....4
		MPT 14-03.....4	MPT 16-G03.....4	
		MPT 14-04.....4	MPT 16-G04.....4	
		MPT 16-03.....4		
		MPT 16-04.....4		

Model (ØD-R)				
	ØD (Inch) - R (NPT) Bag Qty	ØD (Inch) - R (BSPP) Bag Qty	ØD (Metric) - R (BSPT) Bag Qty	ØD (Metric) -R (BSPP) Bag Qty
MPST MALE RUN TEE 	MPST 5/32-N1/8.....10	MPST 5/32-G1/8.....10	MPST 04-M5.....10	MPST 04-G01.....10
	MPST 5/32-N1/4.....10	MPST 5/32-G1/4.....10	MPST 04-01.....10	MPST 04-G02.....10
	MPST 1/4-N1/8.....10	MPST 1/4-G1/8.....10	MPST 04-02.....10	MPST 06-G01.....10
	MPST 1/4-N1/4.....10	MPST 1/4-G1/4.....10	MPST 06-M5.....10	MPST 06-G02.....10
	MPST 1/4-N3/8.....10	MPST 1/4-G3/8.....10	MPST 06-01.....10	MPST 06-G03.....10
	MPST 1/4-N1/2.....10	MPST 1/4-G1/2.....10	MPST 06-02.....10	MPST 06-G04.....5
	MPST 5/16-N1/8.....10	MPST 5/16-G1/8.....10	MPST 06-03.....10	MPST 08-G01.....10
	MPST 5/16-N1/4.....10	MPST 5/16-G1/4.....10	MPST 06-04.....5	MPST 08-G02.....10
	MPST 5/16-N3/8.....5	MPST 5/16-G3/8.....5	MPST 08-01.....10	MPST 08-G03.....10
	MPST 5/16-N1/2.....5	MPST 5/16-G1/2.....5	MPST 08-02.....10	MPST 08-G04.....5
	MPST 3/8-N1/8.....5	MPST 3/8-G1/8.....5	MPST 08-03.....10	MPST 10-G01.....5
	MPST 3/8-N1/4.....5	MPST 3/8-G1/4.....5	MPST 08-04.....5	MPST 10-G02.....5
	MPST 3/8-N3/8.....5	MPST 3/8-G3/8.....5	MPST 10-01.....5	MPST 10-G03.....5
	MPST 3/8-N1/2.....5	MPST 3/8-G1/2.....5	MPST 10-02.....5	MPST 10-G04.....5
	MPST 1/2-N1/8.....5	MPST 1/2-G1/8.....5	MPST 10-03.....5	MPST 12-G01.....5
	MPST 1/2-N1/4.....5	MPST 1/2-G1/4.....5	MPST 10-04.....5	MPST 12-G02.....5
	MPST 1/2-N3/8.....5	MPST 1/2-G3/8.....5	MPST 12-01.....5	MPST 12-G03.....5
	MPST 1/2-N1/2.....5	MPST 1/2-G1/2.....5	MPST 12-02.....5	MPST 12-G04.....5
			MPST 12-03.....5	MPST 14-G03.....4
			MPST 12-04.....5	MPST 14-G04.....4
		MPST 14-03.....4	MPST 16-G03.....4	
		MPST 14-04.....4	MPST 16-G04.....4	
		MPST 16-03.....4		
		MPST 16-04.....4		

Model (ØD-R)

	ØD (Inch) - R (NPT)	Bag Qty	ØD (Inch) - R (BSPP)	Bag Qty	ØD (Metric) - R (BSPT)	Bag Qty	ØD (Metric) -R (BSPP)	Bag Qty
MPWT MALE Y 	MPWT 5/32-N1/8.....	10	MPWT 5/32-G1/8.....	10	MPWT 04-M5.....	10	MPWT 04-G01.....	10
	MPWT 5/32-N1/4.....	10	MPWT 5/32-G1/4.....	10	MPWT 04-01.....	10	MPWT 04-G02.....	10
	MPWT 1/4-N1/8.....	10	MPWT 1/4-G1/8.....	10	MPWT 04-02.....	10	MPWT 06-G01.....	10
	MPWT 1/4-N1/4.....	10	MPWT 1/4-G1/4.....	10	MPWT 06-M5.....	10	MPWT 06-G02.....	10
	MPWT 1/4-N3/8.....	10	MPWT 1/4-G3/8.....	10	MPWT 06-01.....	10	MPWT 06-G03.....	5
	MPWT 1/4-N1/2.....	10	MPWT 1/4-G1/2.....	10	MPWT 06-02.....	10	MPWT 06-G04.....	5
	MPWT 5/16-N1/8.....	10	MPWT 5/16-G1/8.....	10	MPWT 06-03.....	5	MPWT 08-G01.....	10
	MPWT 5/16-N1/4.....	10	MPWT 5/16-G1/4.....	10	MPWT 06-04.....	5	MPWT 08-G02.....	10
	MPWT 5/16-N3/8.....	5	MPWT 5/16-G3/8.....	5	MPWT 08-01.....	10	MPWT 08-G03.....	5
	MPWT 5/16-N1/2.....	5	MPWT 5/16-G1/2.....	5	MPWT 08-02.....	10	MPWT 08-G04.....	5
	MPWT 3/8-N1/8.....	5	MPWT 3/8-G1/8.....	5	MPWT 08-03.....	5	MPWT 10-G01.....	5
	MPWT 3/8-N1/4.....	5	MPWT 3/8-G1/4.....	5	MPWT 08-04.....	5	MPWT 10-G02.....	5
	MPWT 3/8-N3/8.....	5	MPWT 3/8-G3/8.....	5	MPWT 10-01.....	5	MPWT 10-G03.....	5
	MPWT 3/8-N1/2.....	5	MPWT 3/8-G1/2.....	5	MPWT 10-02.....	5	MPWT 10-G04.....	5
	MPWT 1/2-N1/8.....	5	MPWT 1/2-G1/8.....	5	MPWT 10-03.....	5	MPWT 12-G01.....	5
	MPWT 1/2-N1/4.....	5	MPWT 1/2-G1/4.....	5	MPWT 10-04.....	5	MPWT 12-G02.....	5
	MPWT 1/2-N3/8.....	5	MPWT 1/2-G3/8.....	5	MPWT 12-01.....	5	MPWT 12-G03.....	5
	MPWT 1/2-N1/2.....	5	MPWT 1/2-G1/2.....	5	MPWT 12-02.....	5	MPWT 12-G04.....	5
					MPWT 12-03.....	5	MPWT 14-G03.....	5
					MPWT 12-04.....	5	MPWT 14-G04.....	5
					MPWT 14-03.....	5	MPWT 16-G03.....	5
					MPWT 14-04.....	5	MPWT 16-G04.....	5
					MPWT 16-03.....	5		
					MPWT 16-04.....	5		

Model (ØD)	Model (ØD)	Model (ØD)	Model (ØD)	Model (ØD)
MPMM BULKHEAD UNION 	MPUC UNION 	MPUL UNION ELBOW 	MPUT UNION TEE 	MPY UNION Y 
ØD (Inch) Bag Qty	ØD (Inch) Bag Qty	ØD (Inch) Bag Qty	ØD (Inch) Bag Qty	ØD (Inch) Bag Qty
MPMM 5/32..... 10 MPMM 1/4..... 10 MPMM 5/16..... 10 MPMM 3/8..... 10 MPMM 1/2..... 5	MPUC 5/32..... 10 MPUC 1/4..... 10 MPUC 5/16..... 10 MPUC 3/8..... 10 MPUC 1/2..... 5	MPUL 5/32..... 10 MPUL 1/4..... 10 MPUL 5/16..... 10 MPUL 3/8..... 5 MPUL 1/2..... 5	MPUT 5/32..... 10 MPUT 1/4..... 10 MPUT 5/16..... 10 MPUT 3/8..... 5 MPUT 1/2..... 5	MPY 5/32..... 10 MPY 1/4..... 10 MPY 5/16..... 10 MPY 3/8..... 5 MPY 1/2..... 5
ØD (Metric) Bag Qty	ØD (Metric) Bag Qty	ØD (Metric) Bag Qty	ØD (Metric) Bag Qty	ØD (Metric) Bag Qty
MPMM 04..... 10 MPMM 06..... 10 MPMM 08..... 10 MPMM 10..... 10 MPMM 12..... 5 MPMM 14..... 5 MPMM 16..... 5	MPUC 04..... 10 MPUC 06..... 10 MPUC 08..... 10 MPUC 10..... 10 MPUC 12..... 5 MPUC 14..... 5 MPUC 16..... 5	MPUL 04..... 10 MPUL 06..... 10 MPUL 08..... 10 MPUL 10..... 5 MPUL 12..... 5 MPUL 14..... 5 MPUL 16..... 5	MPUT 04..... 10 MPUT 06..... 10 MPUT 08..... 10 MPUT 10..... 5 MPUT 12..... 5 MPUT 14..... 5 MPUT 16..... 5	MPY 04..... 10 MPY 06..... 10 MPY 08..... 10 MPY 10..... 5 MPY 12..... 5 MPY 14..... 5 MPY 16..... 5

WATER FITTINGS

Application:

- One-touch fittings used for piping drinking water and other beverages
- Wide variety of models available to meet all needs

FEATURES:

- In compliance with FDA for use with drinking water and beverages
- ANSI / NSF 61 certified
- Assembled and packaged in Clean Room



Certified to
NSF/ANSI 61

Maximum Usable Pressure

Size Temperature	5/32"	3/16"	1/4"	5/16"	3/8"	1/2"
	4mm	5mm	6mm	8mm	10mm	12mm
1°C (33.8°F)	230 psi			170 psi		
20°C (68°F)	230 psi			170 psi		
54°C (129.2°F)	150 psi			100 psi		

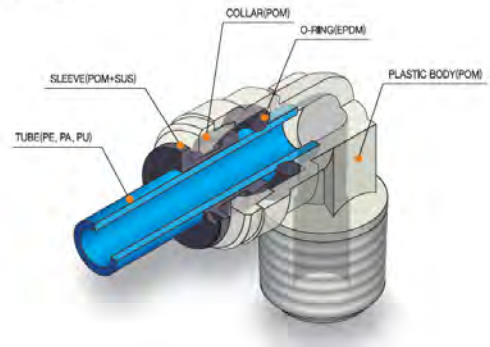

* 5/32" interchangeable with 4mm
5/16" interchangeable with 8mm

Structural Diagram













Specifications		
Fluid	Water, Beverage	
Working Pressure Range	0 ~ 230 psi	0 ~ 1586 kPa
Temperature Range	32 ~ 140F	0 ~ 60C
Applicable Tubing	Polyethylene, Polyamide, Polyurethane	

	Model (ØD-R)				
	ØD (Inch) - R (NPT)	ØD (Inch) - R (BSPT)	ØD (Inch) - R (BSPP)	ØD (Metric) - R (BSPT)	ØD (Metric) - R (BSPP)
WC MALE STRAIGHT 	WC 5/32-N01	WC 5/32-01	WC 5/32-G01	WC 06-01	WC 06-G01
	WC 5/32-N02	WC 5/32-02	WC 5/32-G02	WC 06-02	WC 06-G02
	WC 5/32-N01	WC 3/16-01	WC 3/16-G01	WC 06-03	WC 10-G02
	WC 1/4-N01	WC 3/16-02	WC 3/16-G02	WC 06-04	WC 10-G03
	WC 1/4-N02	WC 1/4-01	WC 1/4-G01	WC 10-01	WC 10-G04
	WC 1/4-N03	WC 1/4-02	WC 1/4-G02	WC 10-02	WC 12-G03
	WC 1/4-N04	WC 1/4-03	WC 5/16-G01	WC 10-03	WC 12-G04
	WC 5/16-N01	WC 1/4-04	WC 5/16-G02	WC 10-04	
	WC 5/16-N02	WC 5/16-01	WC 5/16-G03	WC 12-03	
	WC 5/16-N03	WC 5/16-02	WC 3/8-G02	WC 12-04	
	WC 3/8-N01	WC 5/16-03	WC 3/8-G03		
	WC 3/8-N02	WC 3/8-01	WC 3/8-G04		
	WC 3/8-N03	WC 3/8-02	WC 1/2-G03		
	WC 3/8-N04	WC 3/8-03	WC 1/2-G04		
	WC 1/2-N03	WC 3/8-04			
	WC 1/2-N04	WC 1/2-03			
	WC 1/2-04				

Model (ØD-R)					
	ØD (Inch) - R (NPT)	ØD (Inch) - R (BSPT)	ØD (Inch) - R (BSPP)	ØD (Metric) - R (BSPT)	ØD (Metric) - R (BSPP)
WCF FEMALE STRAIGHT 	WCF 1/4-N01 WCF 1/4-N02 WCF 5/16-N01 WCF 5/16-N02	WCF 5/16-01 WCF 5/16-02	WCF 1/4-G03-C WCF 1/4-G04-C WCF 5/16-G03-C WCF 5/16-G04-C WCF 3/8-G03-C WCF 3/8-G04-C WCF 1/2-G04-C	WCF 06-01 WCF 06-02 WCF 10-01 WCF 10-02	WCF 06-G03-C WCF 06-G04-C WCF 10-G03-C WCF 10-G04-C WCF 12-G04-C
Model (ØD-R)					
	ØD (Inch) - R (NPT)	ØD (Inch) - R (BSPT)	ØD (Inch) - R (BSPP)	ØD (Metric) - R (BSPT)	ØD (Metric) - R (BSPP)
WCJ PLUG-IN MALE 	WCJ 5/32-N01 WCJ 5/32-N02 WCJ 1/4-N01 WCJ 1/4-N02 WCJ 5/16-N01 WCJ 5/16-N02 WCJ 5/16-N03	WCJ 5/16-01 WCJ 5/16-02 WCJ 5/16-03	WCJ 5/16-G01 WCJ 5/16-G02 WCJ 5/16-G03 WCJ 3/8-G03 WCJ 3/8-G04	WCJ 06-01	WCJ 06-G01 WCJ 06-G02

Model (ØD-R)	Model (ØD)			
WL MALE ELBOW	WUL UNION ELBOW	WLJ PLUG-IN ELBOW	WZA UNION CROSS	WMM BULKHEAD UNION
				
ØD (Inch) - R (NPT)	ØD (Inch)	ØD (Inch)	ØD (Inch)	ØD (Inch)
WL 3/16-N01 WL 1/4-N01 WL 1/4-N02 WL 1/4-N03 WL 5/16-N02 WL 5/16-N03 WL 3/8-N02 WL 3/8-N03 WL 1/2-N03 WL 1/2-N04	WUL 5/32 WUL 3/16 WUL 1/4-3/16 WUL 1/4 WUL 5/16-5/32 WUL 5/16-1/4 WUL 5/16 WUL 3/8-1/4 WUL 3/8-5/16 WUL 3/8 WUL 1/2-1/4 WUL 1/2-5/16 WUL 1/2-3/8 WUL 1/2	WLJ 5/32 WLJ 3/16 WLJ 1/4 WLJ 1/4-3/8 WLJ 5/16-1/4 WLJ 5/16 WLJ 5/16-3/8 WLJ 3/8-1/4 WLJ 3/8 WLJ 1/2-3/8 WLJ 1/2	WZA 5/32 WZA 1/4 WZA 5/16 WZA 3/8 WZA 1/2	WMM 5/32 WMM 3/16 WMM 1/4 WMM 1/4-3/8 WMM 5/16 WMM 3/8-1/4 WMM 3/8 WMM 1/2
ØD (Inch) - R (BSPT)				
WL 1/4-01 WL 1/4-02 WL 5/16-02 WL 5/16-03				
ØD (Metric) - R (BSPT)	ØD (Metric)	ØD (Metric)	ØD (Metric)	ØD (Metric)
WL 06-01 WL 06-02 WL 06-03 WL 10-02 WL 10-03 WL 12-03 WL 12-04	WUL 06 WUL 10 WUL 12	WLJ 06 WLJ 10-06 WLJ 10 WLJ 12	WZA 06 WZA 10 WZA 12	WMM 06 WMM 10 WMM 12

Model (ØD)				
WUC UNION STRAIGHT  ØD	WUT UNION TEE  ØD	WY UNION Y  ØD	WY(3) 3 PORT UNION  ØD ØD2	WU UNION U  ØD
ØD (Inch)	ØD (Inch)	ØD (Inch)	ØD (Inch)	ØD (Inch)
WUC 5/32 WUC 3/16 WUC 1/4 WUC 5/16 WUC 3/8 WUC 1/2	WUT 5/32 WUT 3/16 WUT 1/4 WUT 5/16 WUT 3/8 WUT 1/2	WY 5/32 WY 1/4 WY 5/16 WY 3/8 WY 1/2	WY(3) 3/8-1/4	WU 1/4 WU 5/16
ØD (Metric)	ØD (Metric)	ØD (Metric)		
WUC 06 WUC 10 WUC 12	WUT 06 WUT 10 WUT 12	WY 06 WY 10 WY 12		

Model (ØD-ØD2)				
WG REDUCER  ØD ØD2	WUG REDUCER TEE  ØD ØD2	WGJ PLUG-IN REDUCER  ØD ØD2	WJH PLUG-IN BARB  ØD ØD2	WJHL PLUG-IN BARB ELBOW  ØD ØD2
ØD(Inch) - ØD2(Inch)	ØD(Inch) - ØD2(Inch)	ØD(Inch) - ØD2(Inch)	ØD(Inch) - ØD2(Inch)	ØD(Inch) - ØD2(Inch)
WG 1/4-5/32 WG 5/16-5/32 WG 5/16-1/4 WG 3/8-5/32 WG 3/8-1/4 WG 3/8-5/16 WG 1/2-5/16 WG 1/2-3/8	WUG 1/4-5/16 WUG 1/4-3/8 WUG 5/16-1/4 WUG 5/16-3/8 WUG 3/8-1/4 WUG 3/8-5/16 WUG 1/2-3/8	WGJ 3/16-5/32 WGJ 1/4-5/32 WGJ 5/16-5/32 WGJ 5/16-1/4 WGJ 5/16-3/8 WGJ 3/8-1/4 WGJ 3/8-5/16 WGJ 1/2-5/16 WGJ 1/2-3/8	WJH 1/4-1/4 WJH 5/16-3/8 WJH 3/8-5/16 WJH 3/8-3/8 WJH 3/8-1/2 WJH 1/2-3/8	WJHL 1/4-1/4 WJHL 1/4-5/16
		ØD(Metric) - ØD2(Inch)		
		WGJ 06-5/32 WGJ 06-3/16		

Model (ØD)	
WP PLUG  ØD	
ØD (Inch)	ØD (Metric)
WP 5/32 WP 3/16 WP 1/4 WP 5/16 WP 3/8 WP 1/2	WP 06 WP 10 WP 12

Model (ØD)	
WPF CAP  ØD	
ØD (Inch)	ØD (Metric)
WPF 5/32 WPF 3/16 WPF 1/4 WPF 5/16 WPF 3/8 WPF 1/2	WPF 06 WPF 10 WPF 12

SPEED CONTROLLERS

APPLICATION:

- Used to control the operating speed of driving device

FEATURES:

- Precision control for optimal flowrates
- Compact and light body permits use in confined spaces
- Composite body swivels on metal base
- Fittings include NBR O--ring and Teflon treated threads



Specifications		
Fluid	AIR (No other gases or liquids)	
Working Pressure Range	0 ~ 150 psi	0 ~ 1034 kPa
Negative Pressure	-14.5 psi	-100 kPa
Temperature Range	32 ~ 140F	0 ~ 60C
Applicable Tubing	Polyurethane and Nylon	

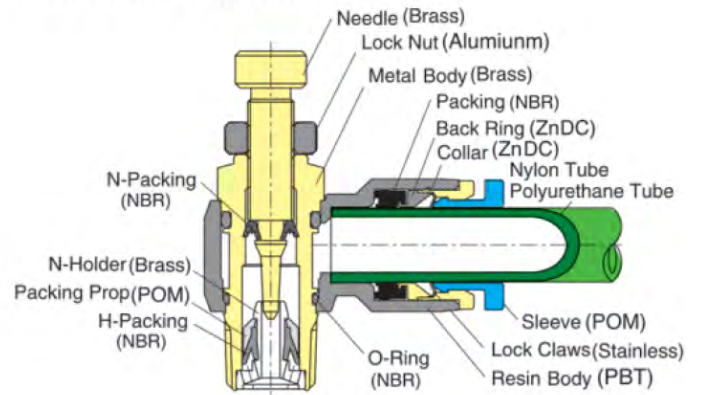

Structural Diagram

METER OUT TYPE

- Control air flow entering from Thread to Sleeve
- Air passes freely from Sleeve to Thread

METER IN TYPE

- Control air flow entering from Sleeve to Thread
- Air passes freely from Thread to Sleeve



UNION TYPE

- Pipe in accordance with signal on the body

Model (ØD-R)								
	ØD (Inch) - R (NPT)	Bag Qty	ØD (Inch) - R (BSPT)	Bag Qty	ØD (Metric) - R (BSPT)	Bag Qty	ØD (Metric) -R (BSPP)	Bag Qty
NSE ELBOW 	NSE 5/32-N01U EPNI	10	NSE 1/4-M5 EPNI.....	10	GNSE 0401 EPNI.....	10	GNSE 04G01 EPNI.....	10
	NSE 5/32-U10U EPNI	10	NSE 1/4-R01 EPNI.....	10	GNSE 0402 EPNI.....	10	GNSE 04G02 EPNI.....	10
	NSE 3/16-N01U EPNI	10	NSE 1/4-R02 EPNI.....	10	GNSE 04M5 EPNI.....	10	GNSE 06G01 EPNI.....	10
	NSE 3/16-N02U EPNI	10	NSE 1/4-R03 EPNI.....	5	GNSE 0601 EPNI.....	10	GNSE 06G02 EPNI.....	10
	NSE 3/16-N03U EPNI	5	NSE 5/16-R01 EPNI.....	10	GNSE 0602 EPNI.....	10	GNSE 06G03 EPNI.....	5
	NSE 3/16-U10U EPNI	10	NSE 5/16-R02 EPNI.....	10	GNSE 0603 EPNI.....	5	GNSE 08G01 EPNI.....	10
	NSE 1/4-N01U EPNI	10	NSE 5/16-R03 EPNI.....	5	GNSE 06M5 EPNI.....	10	GNSE 08G02 EPNI.....	10
	NSE 1/4-N02U EPNI	10	NSE 3/8-R02 EPNI.....	5	GNSE 0801 EPNI.....	10	GNSE 08G03 EPNI.....	5
	NSE 1/4-N03U EPNI	5	NSE 3/8-R03 EPNI.....	5	GNSE 0802 EPNI.....	10	GNSE 08G04 EPNI.....	5
	NSE 1/4-U10U EPNI	10	NSE 3/8-R04 EPNI.....	5	GNSE 0803 EPNI.....	5	GNSE 10G02 EPNI.....	5
	NSE 5/16-N01U EPNI	10			GNSE 0804 EPNI.....	5	GNSE 10G03 EPNI.....	5
	NSE 5/16-N02U EPNI	10			GNSE 1002 EPNI.....	5	GNSE 10G04 EPNI.....	5
	NSE 5/16-N03U EPNI	10			GNSE 1003 EPNI.....	5	GNSE 12G03 EPNI.....	5
	NSE 5/16-N04U EPNI	5			GNSE 1004 EPNI.....	5	GNSE 12G04 EPNI.....	5
	NSE 3/8-N02U EPNI	5			GNSE 1202 EPNI.....	5		
	NSE 3/8-N03U EPNI	5			GNSE 1203 EPNI.....	5		
	NSE 3/8-N04U EPNI	5			GNSE 1204 EPNI.....	5		
	NSE 1/2-N03U EPNI	5						
	NSE 1/2-N04U EPNI	5						

Model (ØD-R)						
	ØD (Inch) - R (NPT)	Bag Qty	ØD (Inch) - R (BSPT)	Bag Qty	ØD (Metric) - R (BSPT)	Bag Qty
NSE-C ELBOW COMPACT 	NSE 1/8-U10UC EPNI.....	10	NSE 1/8-M3C EPNI.....	10	NSE 03M3C EPNI.....	10
	NSE 5/32-U10UC EPNI.....	10	NSE 1/8-M5C EPNI.....	10	NSE 03M5C EPNI.....	10
	NSE 5/32-N01C EPNI.....	10	NSE 5/32-M3C EPNI.....	10	NSE 04M3C EPNI.....	10
	NSE 1/4-U10UC EPNI.....	10	NSE 5/32-M5C EPNI.....	10	NSE 04M5C EPNI.....	10
	NSE 1/4-N01C EPNI.....	10	NSE 5/32-01C EPNI.....	10	NSE 0401C EPNI.....	10
			NSE 1/4-M5C EPNI.....	10	NSE 06M5C EPNI.....	10
			NSE 1/4-01C EPNI.....	10	NSE 0601C EPNI.....	10
					NSE 0602C EPNI.....	10

Model (ØD-R)						
	ØD (Inch) - R (NPT)	Bag Qty	ØD (Inch) - R (BSPT)	Bag Qty	ØD (Metric) - R (BSPT)	Bag Qty
NSS STRAIGHT 	NSS 5/32-N01U EPNI	10	NSS 5/32-M5 EPNI.....	10	NSS 04M5 EPNI.....	10
	NSS 5/32-U10U EPNI	10	NSS 5/32-01 EPNI.....	10	NSS 0401 EPNI.....	10
	NSS 3/16-N01U EPNI	10	NSS 5/32-02 EPNI.....	10	NSS 0402 EPNI.....	10
	NSS 3/16-N02U EPNI	10	NSS 3/16-M5 EPNI.....	10	NSS 06M5 EPNI.....	10
	NSS 3/16-N03U EPNI	5	NSS 3/16-01 EPNI.....	10	NSS 0601 EPNI.....	10
	NSS 3/16-U10U EPNI	10	NSS 3/16-02 EPNI.....	10	NSS 0602 EPNI.....	10
	NSS 1/4-N01U EPNI	10	NSS 3/16-03 EPNI.....	5	NSS 0603 EPNI.....	5
	NSS 1/4-N02U EPNI	10	NSS 1/4-M5 EPNI.....	10	NSS 0801 EPNI.....	10
	NSS 1/4-N03U EPNI	5	NSS 1/4-01 EPNI.....	10	NSS 0802 EPNI.....	10
	NSS 1/4-U10U EPNI	10	NSS 1/4-02 EPNI.....	10	NSS 0803 EPNI.....	5
	NSS 5/16-N01U EPNI	10	NSS 1/4-03 EPNI.....	5	NSS 0804 EPNI.....	5
	NSS 5/16-N02U EPNI	10	NSS 5/16-01 EPNI.....	5	NSS 1002 EPNI.....	5
	NSS 5/16-N03U EPNI	5	NSS 5/16-02 EPNI.....	10	NSS 1003 EPNI.....	5
	NSS 5/16-N04U EPNI	5	NSS 5/16-03 EPNI.....	5	NSS 1004 EPNI.....	5
	NSS 3/8-N02U EPNI	5	NSS 5/16-04 EPNI.....	5	NSS 1202 EPNI.....	5
	NSS 3/8-N03U EPNI	5	NSS 3/8-02 EPNI.....	5	NSS 1203 EPNI.....	5
	NSS 3/8-N04U EPNI	5	NSS 3/8-03 EPNI.....	5	NSS 1204 EPNI.....	5
	NSS 1/2-N03U EPNI	5	NSS 3/8-04 EPNI.....	5		
	NSS 1/2-N04U EPNI	5	NSS 1/2-02 EPNI.....	5		
			NSS 1/2-03 EPNI.....	5		
			NSS 1/2-04 EPNI.....	5		

Model (ØD)							
	ØD (Inch)	Bag Qty	ØD (Metric)	Bag Qty	ØD (Metric)	Bag Qty	
NSF UNION 	NSF 5/32 EPNI.....	10	GNSF 04 EPNI.....	10	NSF-C UNION COMPACT 	NSF 03C EPNI.....	10
	NSF 3/16 EPNI.....	10	GNSF 06 EPNI.....	5			
	NSF 1/4 EPNI.....	5	GNSF 08 EPNI.....	5			
	NSF 5/16 EPNI.....	5	GNSF 10 EPNI.....	5			
	NSF 3/8 EPNI.....	5	GNSF 12 EPNI.....	4			
	NSF 1/2 EPNI.....	4					

ROTARY JOINTS

APPLICATION:

- Used for supplying air at swiveling or swinging connections

FEATURES:

- Built in bearings suitable for high--speed swiveling connections
- Fittings include NBR O--ring and Teflon treated threads

Specifications		
Fluid	AIR (No other gases or liquids)	
Working Pressure Range	0 ~ 150 psi	0 ~ 1034 kPa
Negative Pressure	-14.5 psi	-100 kPa
Temperature Range	32 ~ 140F	0 ~ 60C
Applicable Tubing	Polyurethane and Nylon	

Maximum Operating RPM							
Tube Dia	Metric	Ø4 mm	Ø6 mm	Ø8 mm	Ø10 mm	Ø12 mm	
	Inch	Ø5/32"	Ø3/16"	Ø1/4"	Ø5/16"	Ø3/8"	Ø1/2"
RPM	Low – NRC, NRL	500	500	500	400	300	250
	High – NHRC, NHRL, NHRS, NHRF	1500	1500	1200	1200	1000	1000

Structural Diagram
High Speed Rotary Joint

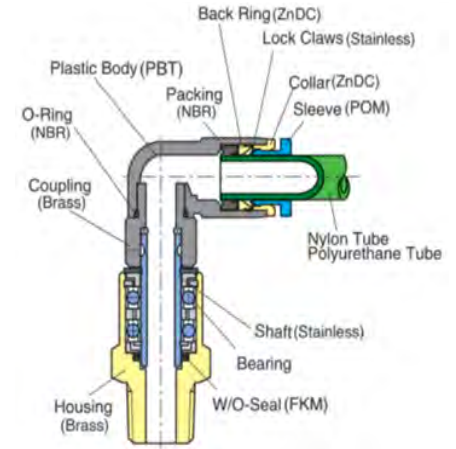

Rotary Joint

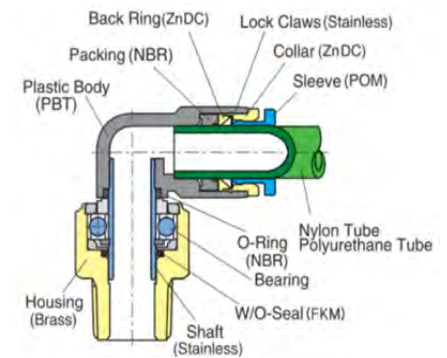

WARNING

- Use PU tubing for high speed rotary joints
- Nylon or other hard tube may overload bearings

Model (ØD-R)

	ØD (Inch) - R (NPT)	ØD (Inch) - R (BSPT)	ØD (Metric) - R (BSPT)	ØD (Metric) -R (BSPP)
NRC STRAIGHT 	NRC 5/32-U10U	NRC 5/32-M5	NRC 04M5	NRC 04G01
	NRC 5/32-N01U	NRC 5/32-R01	NRC 04M6	NRC 06G01
	NRC 3/16-U10U	NRC 3/16-M5	NRC 0401	NRC 06G02
	NRC 3/16-N01U	NRC 3/16-R01	NRC 06M5	NRC 08G01
	NRC 1/4-U10U	NRC 1/4-M5	NRC 06M6	NRC 08G02
	NRC 1/4-N01U	NRC 1/4-R01	NRC 0601	NRC 08G03
	NRC 1/4-N02U	NRC 1/4-R02	NRC 0602	NRC 10G03
	NRC 5/16-N01U	NRC 5/16-R01	NRC 0801	NRC 10G04
	NRC 5/16-N02U	NRC 5/16-R02	NRC 0802	NRC 12G03
	NRC 5/16-N03U	NRC 5/16-R03	NRC 0803	NRC 12G04
	NRC 3/8-N03U	NRC 3/8-R03	NRC 1003	
	NRC 3/8-N04U	NRC 3/8-R04	NRC 1004	
	NRC 1/2-N03U		NRC 1203	
	NRC 1/2-N04U		NRC 1204	

Model (ØD-R)

	ØD (Inch) - R (NPT)	ØD (Inch) - R (BSPT)	ØD (Metric) - R (BSPT)	ØD (Metric) -R (BSPP)
NRL ELBOW 	NRL 5/32-U10U	NRL 5/32-M5	NRL 04M5	NRL 04G01
	NRL 5/32-N01U	NRL 5/32-R01	NRL 04M6	NRL 06G01
	NRL 3/16-U10U	NRL 3/16-M5	NRL 0401	NRL 06G02
	NRL 3/16-N01U	NRL 3/16-R01	NRL 06M5	NRL 08G01
	NRL 1/4-U10U	NRL 1/4-R01	NRL 06M6	NRL 08G02
	NRL 1/4-N01U	NRL 1/4-R02	NRL 0601	NRL 08G03
	NRL 1/4-N02U	NRL 5/16-R01	NRL 0602	NRL 10G03
	NRL 5/16-N01U	NRL 5/16-R02	NRL 0801	NRL 10G04
	NRL 5/16-N02U	NRL 5/16-R03	NRL 0802	NRL 12G03
	NRL 5/16-N03U	NRL 3/8-R03	NRL 0803	NRL 12G04
	NRL 3/8-N03U	NRL 3/8-R04	NRL 1003	
	NRL 3/8-N04U	NRL 1/2-R03	NRL 1004	
	NRL 1/2-N03U	NRL 1/2-R04	NRL 1203	
	NRL 1/2-N04U		NRL 1204	

Model (ØD-R)				
	ØD (Inch) - R (NPT)	ØD (Inch) - R (BSPT)	ØD (Metric) - R (BSPT)	ØD (Metric) - R (BSPP)
NHRC HIGH SPEED STRAIGHT 	NHRC 5/32-U10U NHRC 5/32-N01U NHRC 3/16-U10U NHRC 3/16-N01U NHRC 3/16-N02U NHRC 1/4-N01U NHRC 1/4-N02U NHRC 5/16-N01U NHRC 5/16-N02U NHRC 3/8-N03U NHRC 3/8-N04U NHRC 1/2-N03U NHRC 1/2-N04U	NHRC 5/32-M5 NHRC 5/32-R01 NHRC 3/16-R01 NHRC 1/4-R01 NHRC 1/4-R02 NHRC 5/16-R01 NHRC 5/16-R02 NHRC 3/8-R03 NHRC 3/8-R04 NHRC 1/2-R03 NHRC 1/2-R04	NHRC 04M5 NHRC 04M6 NHRC 0401 NHRC 0601 NHRC 0602 NHRC 0801 NHRC 0802 NHRC 1003 NHRC 1004 NHRC 1203 NHRC 1204	NHRC 04G01 NHRC 06G01 NHRC 06G02 NHRC 08G01 NHRC 08G02 NHRC 10G03 NHRC 10G04 NHRC 12G03 NHRC 12G04

Model (ØD-R)				
	ØD (Inch) - R (NPT)	ØD (Inch) - R (BSPT)	ØD (Metric) - R (BSPT)	ØD (Metric) - R (BSPP)
NHRL HIGH SPEED ELBOW 	NHRL 5/32-U10U NHRL 5/32-N01U NHRL 3/16-U10U NHRL 3/16-N01U NHRL 3/16-N02U NHRL 1/4-N01U NHRL 1/4-N02U NHRL 5/16-N01U NHRL 5/16-N02U NHRL 3/8-N03U NHRL 3/8-N04U NHRL 1/2-N03U NHRL 1/2-N04U	NHRL 1/4-R01 NHRL 1/4-R02 NHRL 5/16-R01 NHRL 5/16-R02 NHRL 3/8-R03 NHRL 3/8-R04 NHRL 1/2-R03 NHRL 1/2-R04	NHRL 04M5 NHRL 04M6 NHRL 0401 NHRL 0601 NHRL 0602 NHRL 0801 NHRL 0802 NHRL 1003 NHRL 1004 NHRL 1203 NHRL 1204	NHRL 04G01 NHRL 06G01 NHRL 06G02 NHRL 08G01 NHRL 08G02 NHRL 10G03 NHRL 10G04 NHRL 12G03 NHRL 12G04

Model (R-Rc)				
	R (NPT) - Rc (NPT)	R (BSPT) - Rc (BSPT)	R (BSPT) - Rc (BSPP)	R (BSPP) - Rc (BSPP)
NHRF HIGH SPEED BUSH 	NHRF N01-N01 NHRF N01-N02 NHRF N02-N01 NHRF N02-N02 NHRF N03-N03 NHRF N03-N04 NHRF N04-N03 NHRF N04-N04	NHRF 01-01 NHRF 01-02 NHRF 02-01 NHRF 02-02 NHRF 03-03 NHRF 03-04 NHRF 04-03 NHRF 04-04	NHRF 01-G01 NHRF 01-G02 NHRF 02-G01 NHRF 02-G02 NHRF 03-G03 NHRF 03-G04 NHRF 04-G03 NHRF 04-G04	NHRF G01-G01 NHRF G01-G02 NHRF G02-G01 NHRF G02-G02 NHRF G03-G03 NHRF G03-G04 NHRF G04-G03 NHRF G04-G04

Model (R1-R2)				
	R1 (NPT) - R2 (NPT)		R1 (BSPT) - R2 (BSPT)	R1 (BSPP) - R2 (BSPP)
NHRS HIGH SPEED NIPPLE 	NHRS N01-N01 NHRS N01-N02 NHRS N02-N01 NHRS N02-N02 NHRS N03-N03 NHRS N03-N04 NHRS N04-N03 NHRS N04-N04		NHRS 01-01 NHRS 01-02 NHRS 02-01 NHRS 02-02 NHRS 03-03 NHRS 03-04 NHRS 04-03 NHRS 04-04	NHRS G01-G01 NHRS G01-G02 NHRS G02-G01 NHRS G02-G02 NHRS G03-G03 NHRS G03-G04 NHRS G04-G03 NHRS G04-G04

STOP FITTINGS

Structural Diagram

APPLICATION:

- Installed where pneumatic connections are changed frequently

FEATURES:

- Air flow is stopped upon disconnection of tube
- Fittings include NBR O-ring and Teflon treated threads

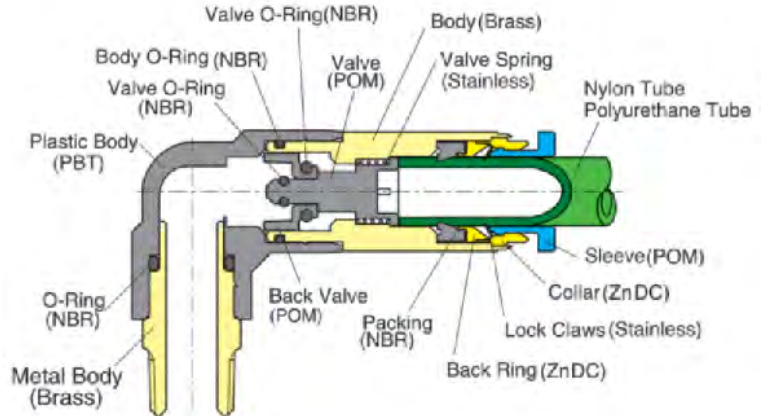

Control Method

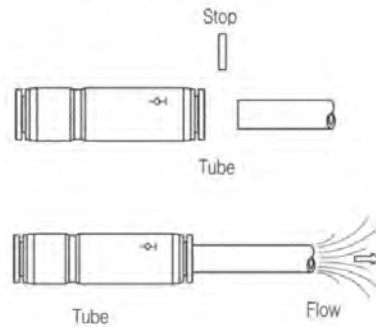





Specifications		
Fluid	AIR (No other gases or liquids)	
Working Pressure Range	0 ~ 150 psi	0 ~ 1034 kPa
Negative Pressure	-14.5 psi	-100 kPa
Temperature Range	32 ~ 140F	0 ~ 60C
Applicable Tubing	Polyurethane and Nylon	



WARNING

- Beware of tube whip up after disconnection

Model (ØD-R)			
	ØD (Inch) - R (NPT)	ØD (Metric) - R (BSPT)	ØD (Metric) - R (BSPP)
SPC STRAIGHT 	SPC 5/32-U10U	SPC 04M5	SPC 04G01
	SPC 5/32-N01U	SPC 0401	SPC 06G01
	SPC 3/16-N01U	SPC 0601	SPC 06G02
	SPC 3/16-N02U	SPC 0602	SPC 08G02
	SPC 1/4-N01U	SPC 0802	SPC 08G03
	SPC 1/4-N02U	SPC 0803	SPC 10G02
	SPC 5/16-N02U	SPC 1002	SPC 10G03
	SPC 5/16-N03U	SPC 1003	SPC 10G04
	SPC 3/8-N03U	SPC 1004	SPC 12G03
	SPC 3/8-N04U	SPC 1203	SPC 12G04
	SPC 1/2-N03U	SPC 1204	
	SPC 1/2-N04U		
	Model (ØD-R)		
	ØD (Inch) - R (NPT)	ØD (Metric) - R (BSPT)	ØD (Metric) - R (BSPP)
SPL ELBOW 	SPL 5/32-U10U	SPL 04M5	SPL 04G01
	SPL 5/32-N01U	SPL 04M6	SPL 06G01
	SPL 3/16-U10U	SPL 0401	SPL 06G02
	SPL 3/16-N01U	SPL 06M5	SPL 08G01
	SPL 3/16-N02U	SPL 0601	SPL 08G02
	SPL 1/4-U10U	SPL 0602	SPL 08G03
	SPL 1/4-N01U	SPL 0801	SPL 10G02
	SPL 1/4-N02U	SPL 0802	SPL 10G03
	SPL 5/16-N01U	SPL 0803	SPL 10G04
	SPL 5/16-N02U	SPL 1002	SPL 12G03
	SPL 5/16-N03U	SPL 1003	SPL 12G04
	SPL 3/8-N02U	SPL 1004	
	SPL 3/8-N03U	SPL 1203	
SPL 3/8-N04U	SPL 1204		
SPL 1/2-N03U			
SPL 1/2-N04U			

Model (ØD)		
	ØD (Inch)	ØD (Metric)
SPU UNION 	SPU 5/32	SPU 04
	SPU 3/16	SPU 06
	SPU 1/4	SPU 08
	SPU 5/16	SPU 10
	SPU 3/8	SPU 12
	SPU 1/2	
Model (ØD)		
	ØD (Inch)	ØD (Metric)
SPUM BULKHEAD UNION 	SPUM N5/32	SPUM 04
	SPUM N3/16	SPUM 06
	SPUM N1/4	SPUM 08
	SPUM N5/16	SPUM 10
	SPUM N3/8	SPUM 12
	SPUM N1/2	

BALL VALVES

APPLICATION:

- Used for controlling air supply in fully open or fully closed positions



FEATURES:

- Versatile PPS resin body allows for use in Air or Water
- Optimized cross sectional design of body maintains flow proportional to tube capacity

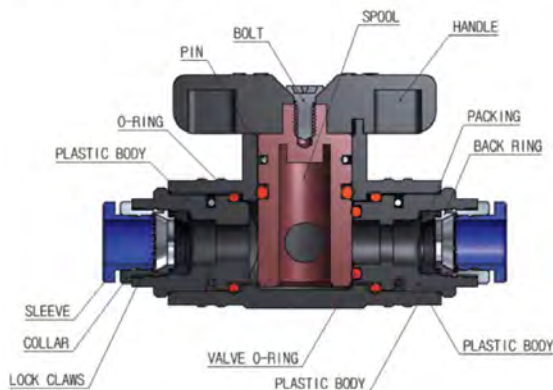
Structural Diagram



Specifications		
Fluid	Air & Water	
Working Pressure Range	0 ~ 284 psi	0 ~ 1958 kPa
Negative Pressure	-14.5 psi	-100 kPa
Temperature Range	32 ~ 176F	0 ~ 80C
Applicable Tubing	Polyurethane and Nylon	

Model (ØD-R)							
	ØD (Inch) - R (NPT)	ØD (Metric) - R (BSPT)	ØD (Metric) - R (BSPP)		ØD (Inch) - R (NPT)	ØD (Metric) - R (BSPT)	ØD (Metric) - R (BSPP)
BC STRAIGHT 	BC 1/4-N1/8	GBC 06-01	GBC 06-G01	BL ELBOW 	BL 5/16-N1/8	GBL 06-01	GBL 06-G01
	BC 1/4-N1/4	GBC 06-02	GBC 06-G02		BL 5/16-N1/4	GBL 06-02	GBL 06-G02
	BC 1/4-N3/8	GBC 06-03	GBC 06-G03		BL 5/16-N3/8	GBL 06-03	GBL 06-G03
	BC 5/16-N1/8	GBC 08-01	GBC 08-G01		BL 1/4-N1/8	GBL 08-01	GBL 08-G01
	BC 5/16-N1/4	GBC 08-02	GBC 08-G02		BL 1/4-N1/4	GBL 08-02	GBL 08-G02
	BC 5/16-N3/8	GBC 08-03	GBC 08-G03		BL 1/4-N3/8	GBL 08-03	GBL 08-G03
	BC 3/8-N1/4	GBC 10-02	GBC 10-G02		BL 3/8-N1/4	GBL 10-02	GBL 10-G02
	BC 3/8-N3/8	GBC 10-03	GBC 10-G03		BL 3/8-N3/8	GBL 10-03	GBL 10-G03
	BC 3/8-N1/2	GBC 10-04	GBC 10-G04		BL 1/2-N1/4	GBL 10-04	GBL 10-G04
	BC 1/2-N1/4	GBC 12-02	GBC 12-G02		BL 1/2-N1/4	GBL 12-02	GBL 12-G02
BC 1/2-N3/8	GBC 12-03	GBC 12-G03	BL 1/2-N3/8	GBL 12-03	GBL 12-G03		
BC 1/2-N1/2	GBC 12-04	GBC 12-G04	BL 1/2-N1/2	GBL 12-04	GBL 12-G04		
	*BC 1/4-R02		*BC 1/2-G03				

Model (ØD)	
BUC UNION 	
ØD (Inch)	ØD (Metric)
BUC 1/4-1/4	GBUC 0606
BUC 5/16-5/16	GBUC 0808
BUC 3/8-3/8	GBUC 1010
BUC 1/2-1/2	GBUC 1212

Model (ØD)	
BUL UNION ELBOW 	
ØD (Inch)	ØD (Metric)
BUL 1/4-1/4	GBUL 0606
BUL 5/16-5/16	GBUL 1010
BUL 3/8-3/8	GBUL 1212
BUL 1/2-1/2	

Model (ØD-ØD2)	
BUG REDUCER 	
ØD(Inch) - ØD2(Inch)	ØD(Metric) - ØD2(Metric)
BUG 5/16-1/4	GBUG 0806
BUG 1/2-3/8	GBUG 1210

Model (ØD-ØD2)	
BLG REDUCER UNION ELBOW 	
ØD(Inch) - ØD2(Inch)	ØD(Metric) - ØD2(Metric)
BLG 1/4-5/16	GBLG 0608
BLG 5/16-1/4	GBLG 0806
BLG 3/8-1/2	GBLG 1012
BLG 1/2-3/8	GBLG 1210

Model (ØD)	
BM BULKHEAD UNION 	
ØD (Inch)	ØD (Metric)
BM 1/4-1/4	GBM 0606
BM 5/16-1/4	GBM 0806
BM 5/16-5/16	GBM 0808
BM 3/8-3/8	GBM 1010
BM 1/2-3/8	GBM 1210
BM 1/2-1/2	GBM 1212

Model (ØD)	
BLM BULKHEAD UNION ELBOW 	
ØD (Inch)	ØD (Metric)
BLM 1/4-1/4	GBLM 0606
BLM 5/16-1/4	GBLM 0806
BLM 5/16-5/16	GBLM 0808
BLM 3/8-3/8	GBLM 1010
BLM 1/2-3/8	GBLM 1210
BLM 1/2-1/2	GBLM 1212

CHECK VALVES

APPLICATION:

- Used for supplying air where one-way flow is desired

FEATURES:

- Check Valve permits airflow in only one direction and closes in reverse direction
- Check Valve keeps 1.42 PSI in vacuum, and opens at low pressures.



Control Method

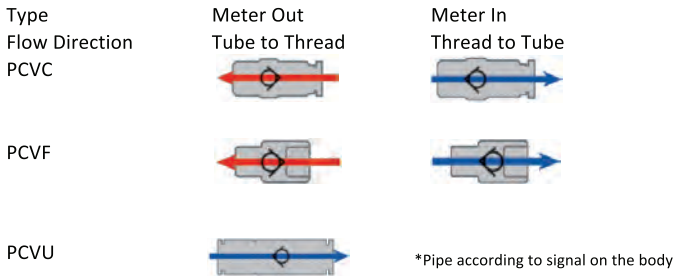

STRUCTURAL DIAGRAM

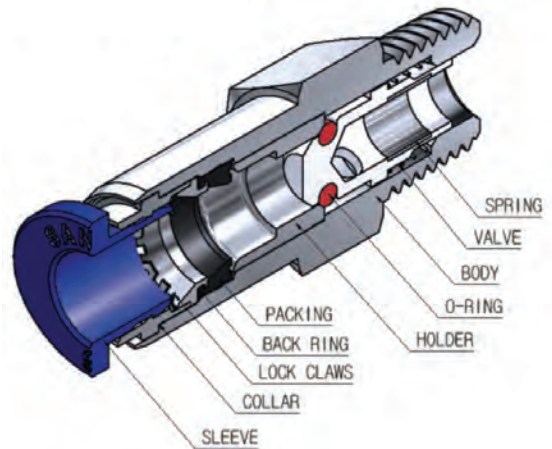

Specifications		
Fluid	AIR (No other gases or liquids)	
Working Pressure Range	0 ~ 284 psi	0 ~ 1958 kPa
Negative Pressure	-14.5 psi	-100 kPa
Temperature Range	32 ~ 176F	0 ~ 80C
Applicable Tubing	Polyurethane and Nylon	

Model (ØD-R)	
PCVC STRAIGHT 	ØD (Metric) - R (BSPT) PCVC 04M5 PCVC 04M6 PCVC 0401 PCVC 0601 PCVC 0602 PCVC 0801 PCVC 0802 PCVC 1003 PCVC 1004 PCVC 1203 PCVC 1204
	ØD (Inch) - R (NPT) ØD (Metric) - R (BSPP) PCVC 5/32-U10U PCVC 04G01 PCVC 5/32-N01U PCVC 06G01 PCVC 3/16-U10U PCVC 06G02 PCVC 3/16-N01U PCVC 08G01 PCVC 3/16-N02U PCVC 08G02 PCVC 1/4-N01U PCVC 10G03 PCVC 1/4-N02U PCVC 10G04 PCVC 5/16-N01U PCVC 12G03 PCVC 5/16-N02U PCVC 12G04 PCVC 3/8-N03U PCVC 3/8-N04U PCVC 1/2-N03U PCVC 1/2-N04U

Model (R-Rc)	
PCVF BUSH 	R (BSPT) - Rc (BSPT) PCVF 0101 PCVF 0202 PCVF 0303 PCVF 0404
	R (NPT) - Rc (NPT) R (BSPP) - Rc (BSPP) PCVF N01-N01 PCVF G01-G01 PCVF N02-N02 PCVF G02-G02 PCVF N03-N03 PCVF G03-G03 PCVF N04-N04 PCVF G04-G04

Model (R-Rc)	
PCVU UNION 	
	ØD (Inch) ØD (Metric) PCVU 5/32 PCVU 04 PCVU 3/16 PCVU 06 PCVU 1/4 PCVU 08 PCVU 5/16 PCVU 10 PCVU 3/8 PCVU 12 PCVU 1/2

HAND VALVES

APPLICATION:

- Used for controlling air supply in fully open or fully closed positions

FEATURES:

- When off, three-way directional control discharges residual outlet pressure while blocking inlet pressure

Structural Diagram

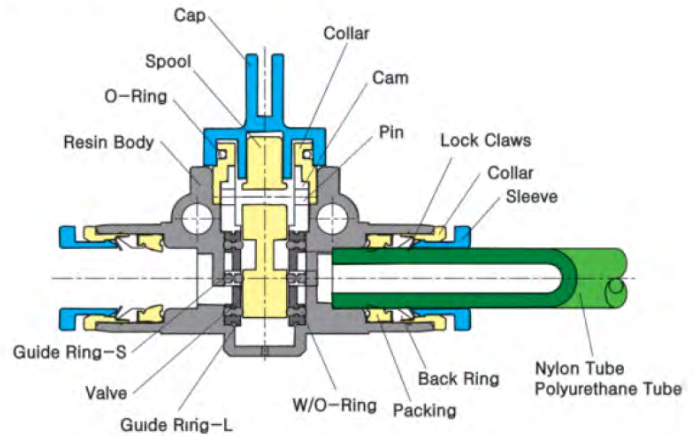

Specifications		
Fluid	AIR (No other gases or liquids)	
Working Pressure Range	0 ~ 284 psi	0 ~ 1958 kPa
Negative Pressure	-14.5 psi	-100 kPa
Temperature Range	32 ~ 176F	0 ~ 80C
Applicable Tubing	Polyurethane and Nylon	

Model (R-R)

HVSS
NIPPLE

R (BSPT) - R (BSPT) R (BSPP) - R (BSPP)

GHVSS 01-01 GHVSS 02-01 GHVSS 02-02 GHVSS 03-02 GHVSS 03-03 GHVSS 04-03 GHVSS 04-04	GHVSS G01-G01 GHVSS G02-G01 GHVSS G02-G02 GHVSS G03-G03 GHVSS G03-G02 GHVSS G04-G03 GHVSS G04-G04
---	---

Model (ØD-R)

HVFS
STRAIGHT

ØD (Metric) - R (BSPT) ØD (Metric) - R (BSPP)

GHVFS 06-01 GHVFS 06-02 GHVFS 06-03 GHVFS 08-01 GHVFS 08-02 GHVFS 08-03 GHVFS 10-02 GHVFS 10-03 GHVFS 10-04 GHVFS 12-02 GHVFS 12-03 GHVFS 12-04	GHVFS 06-G01 GHVFS 06-G02 GHVFS 06-G03 GHVFS 08-G01 GHVFS 08-G02 GHVFS 08-G03 GHVFS 10-G02 GHVFS 10-G03 GHVFS 10-G04 GHVFS 12-G02 GHVFS 12-G03 GHVFS 12-G04
--	--

Model (R-ØD)

HVSF
STRAIGHT

R (BSPT) - ØD (Metric) R (BSPP) - ØD (Metric)

GHVSF 01-06 GHVSF 01-08 GHVSF 02-06 GHVSF 02-08 GHVSF 02-10 GHVSF 02-12 GHVSF 03-06 GHVSF 03-08 GHVSF 03-10 GHVSF 03-12 GHVSF 04-10 GHVSF 04-12	GHVSF G01-06 GHVSF G01-08 GHVSF G02-06 GHVSF G02-08 GHVSF G02-10 GHVSF G02-12 GHVSF G03-06 GHVSF G03-08 GHVSF G03-10 GHVSF G03-12 GHVSF G04-10 GHVSF G04-12
--	--

Model (ØD)

HVFF
UNION

ØD (Metric)

GHVFF 04-04 GHVFF 06-06 GHVFF 08-06 GHVFF 08-08 GHVFF 10-10 GHVFF 12-10 GHVFF 12-12

Model (R-R)

HSV
SLIDE VALVE NIPPLE

R (BSPT) - R (BSPT)

HSV M-01 HSV M-02 HSV M-03 HSV M-04 HSV M-06 HSV M-M5
--

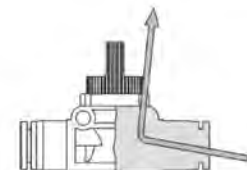

► 3 Way Direction, 2 Way Direction

- The three-way direction control valve, when the air is stopped, discharges residual pressure to the outlet, which assures safety in repairing or adjusting connected devices.
- The two-way direction control valve does not discharge residual pressure, and is suitable for a reservoir tank or other device that does not require a discharging residual pressure.
- The two-way direction control valve is also suitable for the system where a vacuum pipe is used.

MUFFLERS AND BREATHER VENTS

APPLICATION

- Used to filter air, equalize pressure and reduce noise levels
- Breather vents useful for equalizing pressure and filtering in environments without excessive vibration
- Mufflers useful for reducing noise levels on pneumatic devices which are exposed to excessive vibration and heavy shock

FEATURES:

- Wide array of surface treatments and body material to meet all needs
- Standard 40 micron pore size on most filter elements

MUFFLERS AND BREATHER VENTS

PRODUCT CODE SYSTEM

BVS	-	28	-	NP
1		2		3





(1) Type





(2) Thread Size (R)





Inch Size	
Code	Thread
08	10-32 UNF
18	1/8" NPT
28	1/4" NPT
38	3/8" NPT
48	1/2" NPT
68	3/4" NPT
88	1" NPT
128	1-1/4" NPT
148	1-1/2" NPT
200	2" NPT
SAE#4	7/16"-20
SAE#6	9/16"-18
SAE#8	3/4"-16
SAE#10	7/8"-14
SAE#12	1-1/16"-12





(3) Features





Code	Feature
316	SUS316
NP	Nickel Plated
V	Viton Seal







Model									
PEM POLYETHYLENE MUFFLER 		RM RESIN MUFFLER 		HFMA HIGH FLOW ALUMINUM MUFFLER 		FHFMA FEMALE HIGH FLOW ALUMINIUM MUFFLER 		HFSM HIGH FLOW STEEL MUFFLER 	
Thread (NPT)	Bag Qty	Thread (NPT)	Bag Qty	Thread (NPT)	Bag Qty	Thread (NPT)	Bag Qty	Thread (NPT)	Bag Qty
PEM-18.....10		RM-18.....10	10	HFMA-18.....5		FHFMA-128		HFSM-18.....10	
PEM-28.....10		RM-28.....10	10	HFMA-28.....5		FHFMA-148		HFSM-28.....10	
PEM-38.....5		RM-38.....5	5	HFMA-38.....5		FHFMA-200		HFSM-38.....5	
PEM-48.....5		RM-48.....1	1	HFMA-48.....5				HFSM-48.....5	
PEM-68.....5				HFMA-68				HFSM-68	
PEM-88.....5				HFMA-88				HFSM-88	
				HFMA-128				HFSM-128	
				HFMA-148				HFSM-148	
				HFMA-200				HFSM-200	

Model									
FHSFM FEMALE HIGH FLOW STEEL MUFFLER 		HFSS HIGH FLOW STAINLESS STEEL MUFFLER 		HFTO HIGH FLOW FANTO MUFFLER 		HFRAM HIGH FLOW REPAIRABLE MUFFLER 		HFMP HIGH FLOW MUFFLER PLASTIC 	
Thread (NPT)	Bag Qty	Thread (NPT)	Bag Qty	Thread (NPT)	Bag Qty	Thread (NPT)	Bag Qty	Thread (NPT)	Bag Qty
FHSFM-18.....10		HFSS-18.....5	5	HFTO-18.....10	10	HFRAM-18.....10	10	PVI-18.....5	5
FHSFM-28.....10		HFSS-28.....5	5	HFTO-28.....10	10	HFRAM-28.....10	10	PVI-28.....5	5
FHSFM-38.....5		HFSS-38.....5	5	HFTO-38.....5	5	HFRAM-38.....5	5	PVI-38.....5	5
FHSFM-48.....5		HFSS-48.....5	5	HFTO-48.....5	5	HFRAM-48.....5	5	PVI-48.....5	5
		HFSS-68		HFTO-68.....1	1	HFRAM-68.....1	1	PVI-68.....5	5
		HFSS-88		HFTO-88.....1	1	HFRAM-88.....1	1	PVI-88.....5	5
								*REPLACEMENT INSERTS	

Model				
SSBM STAINLESS STEEL MUFFLER 	SCM SPEED CONTROL MUFFLER 	SSSCM STAINLESS STEEL SPEED CONTROL MUFFLER 	SPBMS SPEED CONTROL BRONZE MUFFLER 	BHFA FREE FLOW STRAINER 
Thread (NPT) Bag Qty	Thread (NPT) Bag Qty	Thread (NPT) Bag Qty	Thread (NPT) Bag Qty	Thread (NPT) Bag Qty
SSBM-08 5 SSBM-18 5 SSBM-28 5 SSBM-38 2 SSBM-48 2 SSBM-68 1 SSBM-88 1	SCM-08 10 SCM-18 10 SCM-28 10 SCM-38 10 SCM-48 5 SCM-68 1 SCM-88 1	SSSCM-18 5 SSSCM-28 5 SSSCM-38 2 SSSCM-48 2 SSSCM-68 1 SSSCM-88 1	SPBMS-18 5 SPBMS-28 5 SPBMS-38 5 SPBMS-48 5	BHFA-18 10 BHFA-28 10 BHFA-38 10 BHFA-48 5

Model				
BM SINTERED BRONZE MUFFLER 	BMS SINTERED BRONZE MUFFLER 	FBMS FEMALE SINTERED BRONZE MUFFLER 	BV BREATHER VENT 	BVCH BREATHER PLUG 
Thread (NPT) Bag Qty	Thread (NPT) Bag Qty	Thread (NPT) Bag Qty	Thread (NPT) Bag Qty	Thread (NPT) Bag Qty
BM-08 10 BM-16 10 BM-18 10 BM-28 10 BM-38 10 BM-48 5 BM-68 1 BM-88 1	BM-SAE#6 BM-SAE#8 BM-SAE#12 BMS-18 10 BMS-28 10 BMS-38 10 BMS-48 5 BMS-68 1 BMS-88 1 BMS-128 1 BMS-148 1 BMS-200 1	BMS-08-NP 10 BMS-18-NP 10 BMS-28-NP 10 BMS-38-NP 10 BMS-48-NP 5 BMS-68-NP 1 BMS-88-NP 1	FBMS-18 5 FBMS-28 5 FBMS-38 5 FBMS-48 5 BV-08 10 BV-18 10 BV-28 10 BV-38 10 BV-48 5 BV-68 1 BV-88 1	BV-SAE#4 BV-SAE#6 BV-SAE#8 BV-SAE#10 BV-SAE#12 BVCH-18 5 BVCH-28 5 BVCH-38 5 BVCH-48 5 BVCH-68 5 BVCH-88 1

Model				
BVS BREATHER VENT 	FBVS FEMALE BREATHER VENT 	SBN SCREEN BREATHER VENT 	SSSBN STAINLESS STEEL SCREEN BREATHER VENT 	SSBV STAINLESS STEEL BREATHER VENT 
Thread (NPT) Bag Qty	Thread (NPT) Bag Qty	Thread (NPT) Bag Qty	Thread (NPT) Bag Qty	Thread (NPT) Bag Qty
BVS-18 10 BVS-28 10 BVS-38 10 BVS-48 10 BVS-68 5 BVS-88 1 BVS-128 1 BVS-148 1 BVS-200 1	BVS-08-NP 10 BVS-18-NP 10 BVS-28-NP 10 BVS-38-NP 10 BVS-48-NP 10 BVS-68-NP 1 BVS-88-NP 1	FBVS-18 5 FBVS-28 5 FBVS-38 5 FBVS-48 5 SBN-18 10 SBN-28 10 SBN-38 10 SBN-48 10 SBN-68 5 SBN-88 1	SSSBN-18-316 5 SSSBN-28-316 5 SSSBN-38-316 2 SSSBN-48-316 2 SSSBN-68-316 1 SSSBN-88-316 1	SSBV-18 5 SSBV-28 5 SSBV-38 2 SSBV-48 2 SSBV-68 1 SSBV-88 1

Model						
PGV PLUG BREATHER VENT 	HIF HYDRAULIC INLINE FILTER 	HIL HYDRAULIC INLINE FILTER 	RIF REPAIRABLE INLINE FILTER 	NIF NIPPLE INLINE FILTER 	PS PRESSURE SNUBBER 	
Thread (NPT) Bag Qty	Thread (NPT) Bag Qty	Thread (NPT) Bag Qty	Thread (NPT) Bag Qty	Thread (NPT) Bag Qty	Thread (NPT) Bag Qty	
PGV-18 10 PGV-28 10 PGV-38 10 PGV-48 5	HIF-28 2 HIF-38 2 HIF-48 2 HIF-68 2 HIF-SAE6 2 HIF-SAE8 2	HIF-28V 2 HIF-38V 2 HIF-48V 2 HIF-68V 2 HIF-SAE6V 2 HIF-SAE8V 2	HIL-28 2 HIL-38 2 HIL-SAE6 2 HIL-28V 2 HIL-38V 2 HIL-SAE6V 2	RIF-18 5 RIF-28 5 RIF-38 5 RIF-48 5 RIF-68 1	RIF-48F 1 RIF-68F 1 NIF-18 5 NIF-28 5 NIF-38 5 NIF-48 5	PS-28 5 PS-38 5

AIR GUNS AND TUBING

PRODUCT CODE SYSTEM

	U	-	1/4	(100F	BK)
(1) Type	1		2	3	4

(2) Tube Diameter (ØD)

Inch Size	
Code	Outer Dia
1/8	1/8"
5/32	5/32"
3/16	3/16"
1/4	1/4"
5/16	5/16"
3/8	3/8"
1/2	1/2"

Metric Size		
Code	Outer Dia	Inner Dia
04020	4 mm	2 mm
04025	4 mm	2.5 mm
06040	6 mm	4 mm
08050	8 mm	5 mm
10065	10 mm	6.5 mm
12080	12 mm	8 mm
16110	16 mm	11 mm
16120	16 mm	12 mm

(3) Length

Code	Length
100F	100 ft
500F	500 ft
50M	50 m
100M	100 m
200M	200 m
S	25 mm Nozzle
M	105 mm Nozzle
L	221 mm Nozzle

(4) Color

Code	Color
BK	Black
BU	Blue
C	Clear
G	Green
R	Red
W	White
Y	Yellow

POLYURETHANE TUBING

APPLICATION:

- Used for piping air tools, industrial machinery and various other pneumatic systems

FEATURES:

- Higher flexibility than nylon while offering superior kink resistance and overall strength

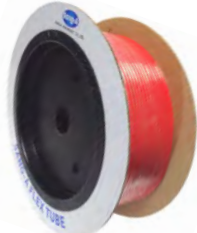
Model (ØD)	Tube (ØD)	
	Tube (Inch O.D.)	Tube (Metric O.D. - I.D.)
U POLYURETHANE TUBING 	U 1/8(100F *)	U-04020(200M *)
	U 1/8(500F *)	U-04025(200M *)
	U 5/32(100F *)	U-06040(100M *)
	U 5/32(500F *)	U-08050(100M *)
	U 3/16(100F *)	U-10065(100M *)
	U 3/16(500F *)	U-12080(100M *)
	U 1/4(100F *)	U-16110(50M *)
	U 1/4(500F *)	U-16120(50M *)
	U 5/16(100F *)	
	U 5/16(500F *)	
	U 3/8(100F *)	
	U 3/8(500F *)	
	U 1/2(100F *)	
	U 1/2(500F *)	

* Refer to Product Code System for available colors

Working Pressure

- Temperature limits of tube : -40°C~80°C
- Normal Pressure : Control normal pressure within 1/3 of tube burst pressure.

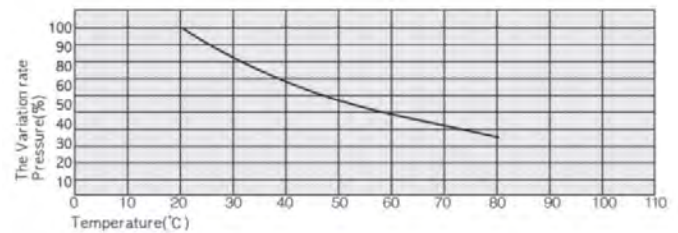

AIR GUNS

APPLICATION:

- Used for cleaning debris and particles with compressed air

FEATURES:

- Various nozzle sizes allow ease of cleaning in confined spaces

Model (ØD-Rc)	ØD (Metric) - Rc (BSPT)
AG-S 	AIR GUN 0802 S(BK)
	AIR GUN 0802 S(BU)
	AIR GUN 0802 S(R)
	AIR GUN 1002 S(BK)
	AIR GUN 1002 S(BU)
	AIR GUN 1002 S(R)
	AIR GUN 1003 S(BK)
	AIR GUN 1003 S(BU)
	AIR GUN 1003 S(R)

Model (ØD-Rc)	ØD (Metric) - Rc (BSPT)
AG-M 	AIR GUN 0802 M(BK)
	AIR GUN 0802 M(BU)
	AIR GUN 0802 M(R)
	AIR GUN 1002 M(B)
	AIR GUN 1002 M(BU)
	AIR GUN 1002 M(R)
	AIR GUN 1003 M(BK)
	AIR GUN 1003 M(BU)
	AIR GUN 1003 M(R)

Model (ØD-Rc)	ØD (Metric) - Rc (BSPT)
AG-L 	AIR GUN 0802 L(BK)
	AIR GUN 0802 L(BU)
	AIR GUN 0802 L(R)
	AIR GUN 1002 L(BK)
	AIR GUN 1002 L(BU)
	AIR GUN 1002 L(R)
	AIR GUN 1003 L(BK)
	AIR GUN 1003 L(BU)
	AIR GUN 1003 L(R)