

Large Bore Extruded Cylinders, ISO 6431 Series 41

EXPRESS DELIVERY AVAILABLE

Double-acting cushioned, magnetic
 ø160 - 200 (DIN/ISO 6431)

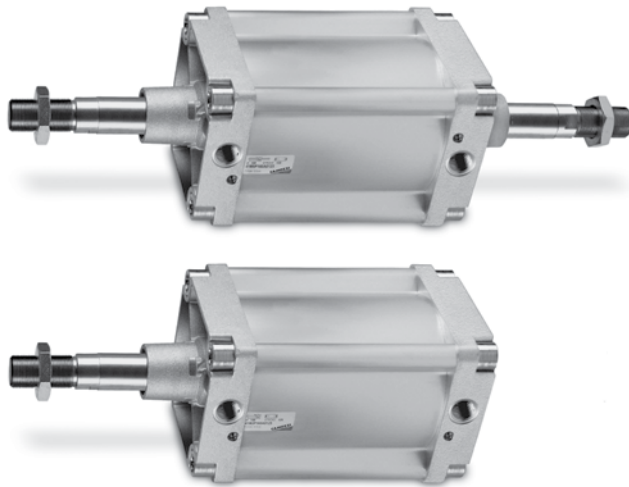

- » DIN/ISO 6431 VDMA 24562
- » Rolled stainless steel rod
- » Adjustable cushioning
- » Aluminum Profile

Cylinders Series 41 with diameters 160 and 200 have been designed so as to comply with the dimensions laid down in the DIN/ISO 6431 standards. The extruded aluminium tube in this series is regarded as very aesthetically pleasing.

The mounting brackets used on the end-caps tube are designed in an extremely secure way, making use of the cylinder tie-rods positioned internally and not visible on the assembled cylinders. This cylinder series is normally equipped with adjustable cushioning. Moreover, to reduce the noise of the impact of the piston and end-caps, these cylinders are equipped with a mechanical cushioning.

GENERAL DATA

Type of construction	with tie-rods
Operation	double-acting
Materials	end-caps = AL; other parts: see coding
Mounting	with tie-rods, front flange, rear flange, feet, centre trunnion, front and rear trunnion, swivel combination
Strokes min - max	10 – 2500 mm
Operating temperature	0°C – 80°C (with dry air - 20°C) (32 - 176°F, with dry air -4°F)
Operating pressure	1 – 10 bar
Speed	10 – 500 mm/sec (without load)
Fluid	filtered air, without lubrication. If lubricated air is used, it is recommended to use oil ISOVG32. Once applied the lubrication should never be interrupted.

STANDARD STROKES FOR DOUBLE-ACTING CYLINDERS SERIES 41

✕ = Double-acting

MAXIMUM STROKE LENGTHS (mm)

Series (and Ø)	Min-Max Stroke (Produced in USA)	Min-Max Stroke (Produced in Italy)
40, 41 (Ø 160-320)	10-1500 mm	10-2500 mm

STANDARD STROKES

Ø	25	50	75	80	100	125	150	160	200	250	300	320	400	500
160		✕			✕		✕		✕				✕	✕
200		✕			✕				✕					

CODING EXAMPLE

41	M	2	P	160	A	0200	
----	---	---	---	-----	---	------	--

41	SERIES
M	VERSION M = standard magnetic
2	OPERATION 2 = double-acting (front and rear cushions) 3 = double-acting (no cushion) 4 = double-acting (rear cushions) 5 = double-acting (front cushion) 6 = double-acting (through-rod with front and rear cushions)
P	MATERIALS P = see the general data on page 1/1.15.01 R = stainless steel AISI 420B tie-rods, stainless steel AISI 303 tie-rod nuts C = rolled stainless steel AISI 303 piston rod, stainless steel AISI 304 piston rod nut U = rolled stainless steel AISI 303 piston rod, stainless steel AISI 304 piston rod nut, stainless steel AISI 420B tie-rods, stainless steel AISI 303 tie-rod nuts W = rolled stainless steel AISI 304 piston rod, stainless steel AISI304 piston rod nut, stainless steel AISI 420B tie-rods, stainless steel AISI 303 tie-rod nuts
160	BORE 160 = 160 mm 200 = 200 mm
A	TYPE OF DESIGN A = tie-rods F = cylinder with centre trunnion
0200	STROKE see table
	= standard V = FKM rod seals W = all FKM seals, up to 140°C C = PU coated cylinder. Color: Grey * (___) = extended piston rod ___ mm
	* The C version is available on request. For further information, please contact our technical department.

ACCESSORIES FOR CYLINDERS SERIES 41

MAXIMUM STROKE LENGTHS (mm)		
Series (and Ø)	Min-Max Stroke (Produced in USA)	Min-Max Stroke (Produced in Italy)
40, 41 (Ø 160-320)	10-1500 mm	10-2500 mm



Clevis pin Mod. S



90° swivel combination Mod. ZS

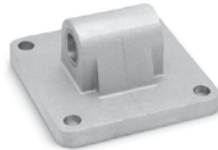

Rear trunnion, male Mod. L

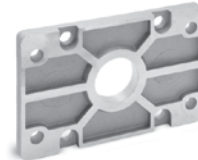

Front and rear flange Mod. D-E



Counter bracket for centre trunnion Mod. BF



Centre trunnion Mod. F



Foot mount Mod. B



Rod fork end Mod. G

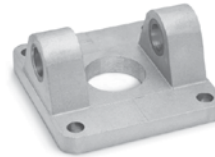

Front and rear female trunnion Mod. C-H



Swivel ball joint Mod. GA



Swivel combination Mod. I



Piston rod nut Mod. U



All accessories are supplied separately, except for the piston rod nut Mod. U

EXPRESS DELIVERY AVAILABLE

Cylinders Series 41



+ = add the stroke

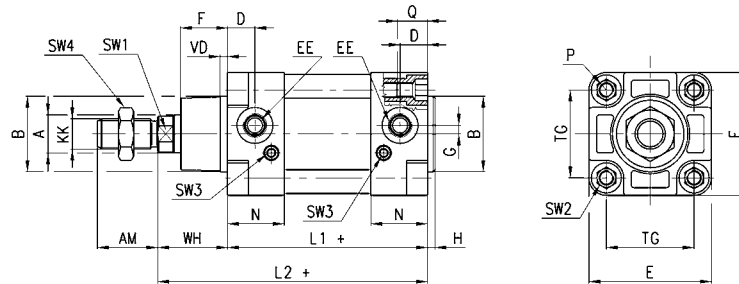

DIMENSIONS (mm)

Ø	ØA	KK	ØB	D	G	F	AM	H	EE	WH	L1+	L2+	VD	N	P	Q	TG	E	SW1	SW2	SW3	SW4	cushioning front/rear
160	40	M36x2	65	25	12	53.5	72	6	G3/4	80	180	260	6	45	M16	26	140	176	36	17	4	55	29 / 36
200	40	M36x2	75	25	12	63.5	72	6	G3/4	95	180	275	6	45	M16	26	175	216	36	17	4	55	44 / 42

Cylinders Series 41 - through-rod



+ = add the stroke
++ = add the stroke 2 times

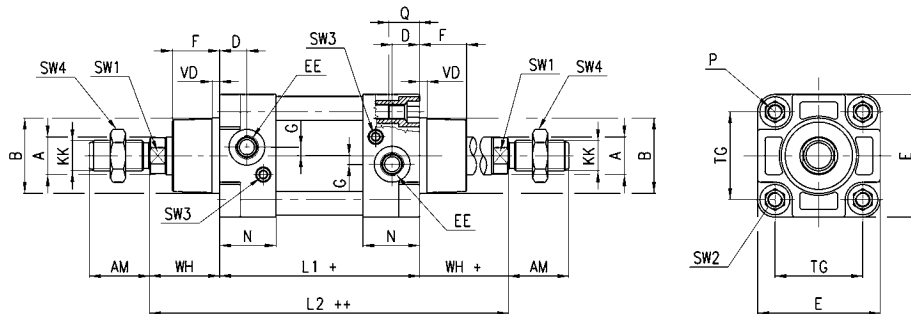

DIMENSIONS (mm)

Ø	A	KK	B	D	G	F	AM	EE	WH	L1+	L2++	VD	N	P	Q	TG	E	SW1	SW2	SW3	SW4	cushioning front/rear
160	40	M36x2	65	25	12	53.5	72	G3/4	80	180	340	6	45	M16	26	140	176	36	17	4	55	29 / 36
200	40	M36x2	75	25	12	63.5	72	G3/4	95	180	370	6	45	M16	26	175	216	36	17	4	55	44 / 42

Cylinders Series 41 with centre trunnion Mod. F

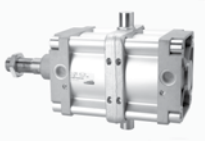

+ = add the stroke

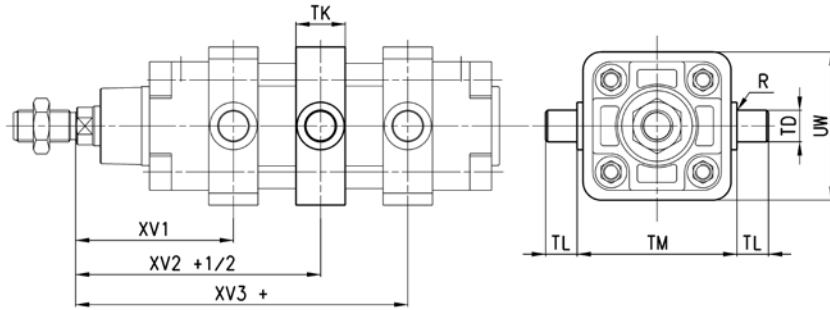

DIMENSIONS (mm)										
Ø	XV1	XV2	XV3	TM	TK	TD	TL	UW	R	
160	145	170	195	200	40	32	32	200	0,2	
200	160	185	210	250	40	32	32	250	0,2	

EXPRESS DELIVERY AVAILABLE

Foot mount Mod. B



Material: black-painted steel (cataphoresis)
 Supplied with:
 2x feet
 4x screws

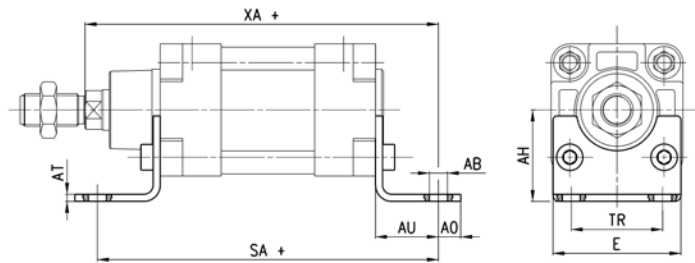

+ = add the stroke

DIMENSIONS (mm)

Mod.	∅	AT	SA+	XA+	TR	E	∅AB	AH	AO	AU
B-41-160	160	10	300	320	115	175	18	115	20	60
B-41-200	200	11	320	345	135	215	22	135	30	70

Front and rear flange Mod. D-E

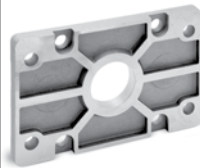

Material: Aluminium.
 Supplied with:
 1x flange
 4x screws

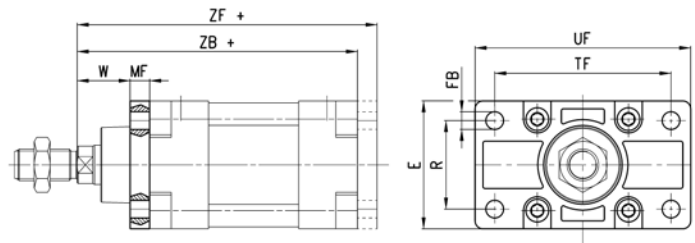

+ = add the stroke

DIMENSIONS (mm)

Mod.	∅	W	MF	ZB+	TF	R	UF	E	∅FB	ZF+
D-E-41-160	160	60	20	260	230	115	276	175	18	280
D-E-41-200	200	70	25	275	270	135	312	215	22	300

Front and rear female trunnion Mod. C-H

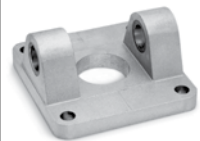

Material: Aluminium.
 Supplied with:
 1x female trunnion
 4x screws

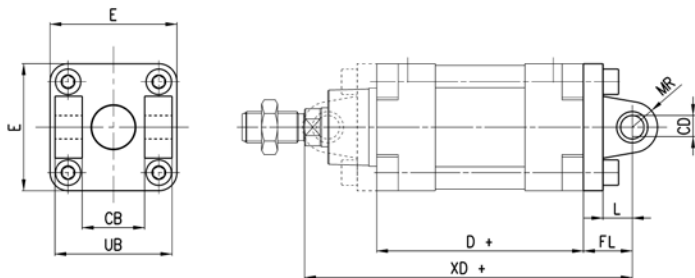

+ = add the stroke

DIMENSIONS (mm)

Mod.	∅	∅CD	L	FL	D+	XD+	MR	E	CB	UB
C-H-41-160	160	30	35	55	180	315	30	175	90	170
C-H-41-200	200	30	35	60	180	335	30	215	90	170

Rear male trunnion Mod. L

Material: Aluminium
 Supplied with:
 1x male trunnion
 4x screws

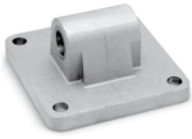

+ = add the stroke

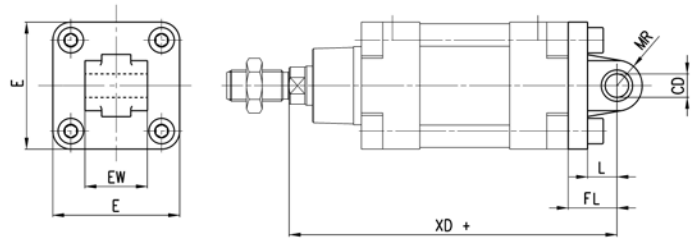

DIMENSIONS (mm)

Mod.	∅	∅CD	L	FL	XD+	MR	E	EW ^{-0.5-1.2}
L-41-160	160	30	35	55	315	30	175	90
L-41-200	200	30	35	60	335	30	215	90

Centre trunnion Mod. F

Material: white zinc-plated steel.
 Supplied with:
 1x centre trunnion
 4x clamping elements
 4x locking screws



+ = add the stroke

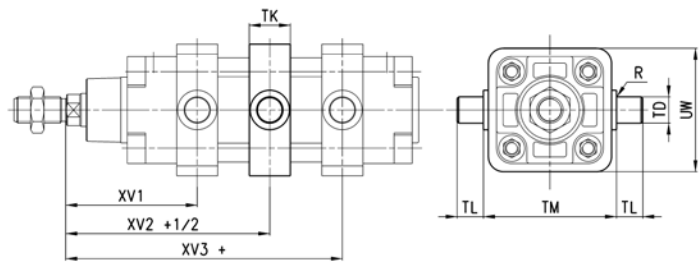

DIMENSIONS (mm)

Mod.	∅	XV1	XV+1/2	XV3+	TM	h	∅TD	TL	UW	R
F-41-160	160	145	170	195	200	40	32	32	200	0.2
F-41-200	200	160	185	210	250	40	32	32	250	0.2

90° Swivel combination Mod. ZS*

Material: Aluminium
 * not according to standard



+ = add the stroke

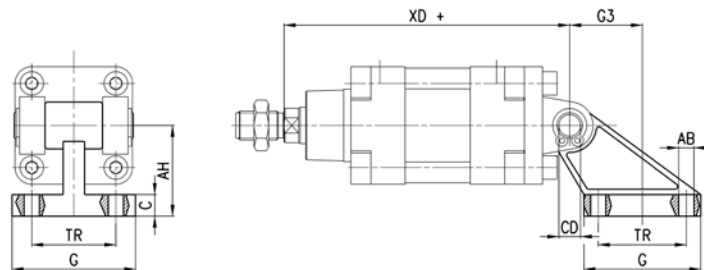

DIMENSIONS (mm)

Mod.	∅	TR	∅AB	AH	C	G	∅CD	XD+	G3
ZS-160	160	140	18	140	20	180	30	315	105
ZS-200	200	175	18	140	25	220	30	335	125

EXPRESS DELIVERY AVAILABLE

Swivel combination Mod. I (combination of C + L + S)

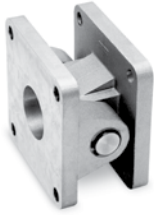

+ = add the stroke

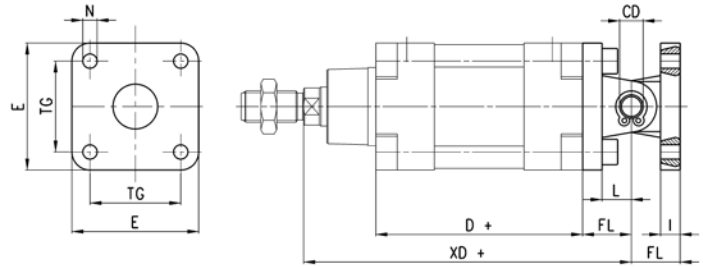

DIMENSIONS (mm)

Mod.	Ø	ØCD	L	FL	D+	XD+	TG	E	ØN	I
I-41-160	160	30	35	55	180	315	140	175	17	20
I-41-200	200	30	35	60	180	335	175	215	17	25

Counter bracket for centre trunnion Mod. BF



Material: Aluminium.
Supplied with:
2x supports

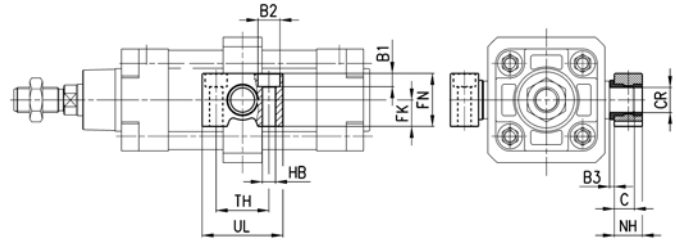

DIMENSIONS (mm)

Mod.	Ø	ØCR	NH	C	B3	TH	UL	FK	FN	B1	ØB2	ØHB
BF-160-200	160-200	32	35	17,5	4	60	92	30	60	16	26	18

Rod fork end Mod. G



ISO 8140.
Material: zinc-plated steel.

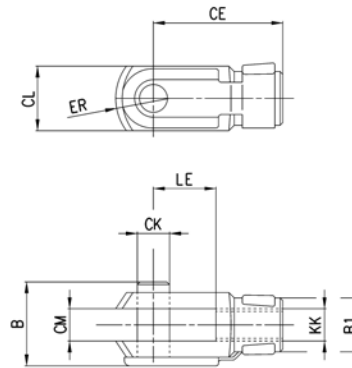

DIMENSIONS (mm)

Mod.	Ø	ØCK	LE	CM	CL	ER	CE	KK	B	ØB1
G-160-200	160-200	35	72	35	70	44	144	M36X2	92	60

Swivel ball joint Mod. GA

ISO 8139.
Material: zinc-plated steel.

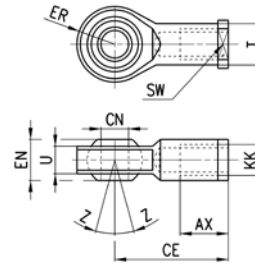

DIMENSIONS (mm)

Mod.	∅	∅CN	U	EN	ER	AX	CE	KK	∅T	Z	SW
GA-160-200	160-200	35	28	43	40	56	125	M36x2	46	6	50

Clevis pin Mod. S

Supplied with:
1x clevis pin (stainless steel 303)
2x C-clips (plain carbon steel)

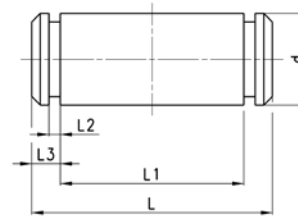

DIMENSIONS (mm)

Mod.	∅	d	L	L1	L2	L3
S-160-200	160-200	30	179	170	1,6	4,25

Piston rod nut Mod. U

UNI EN ISO 4035.
Material: zinc-plated steel.

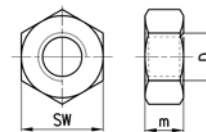

DIMENSIONS (mm)

Mod.	∅	D	m	SW
U-160-200	160-200	M36x2	14	55