

# BVCH-Series, Breather Vent with Splash Guard

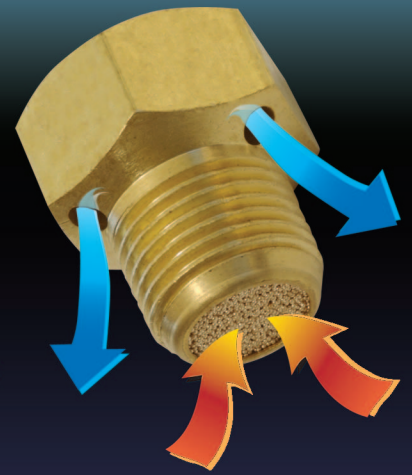
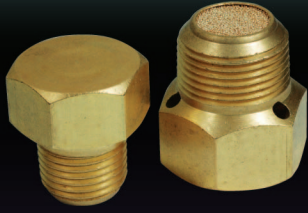

BVCH-Series breather vent allow free exchange of filtered air for gear boxes, crank cases or storage tanks vented to atmosphere. The top of breather is closed off but has multiple holes drilled at 60-deg upward angle just below the hex head to prevent unwanted fluid from entering during periodic wash cycle or splashes.

Solid brass construction, it is rugged and corrosion resistant. Supplied with standard male pipe or SAE thread, unit should be mounting vertically and avoid excessive vibration. Use wrench on hex head to tighten unit to the device. The standard filter element is 100 micron, optional 10 or 40 micron is available; complete stainless-steel construction is also possible on special order.

## SYMBOL

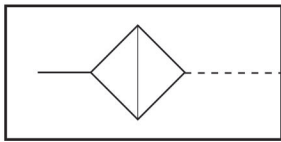

## HOW TO ORDER

<b>BVCH -</b>	<input type="checkbox"/> <input type="checkbox"/>	-	<input type="checkbox"/> <input type="checkbox"/>
Breather Vent Plug	<u>Connection</u>		<u>Element Porosity</u>
	18 = 1/8" NPT	SAE#4 = 7/16"-20	None = 100um (standard)
	28 = 1/4" NPT	SAE#6 = 9/16"-18	10 = 10um
	38 = 3/8" NPT	SAE#8 = 3/4"-16	40 = 40um
	48 = 1/2" NPT		
	68 = 3/4" NPT		
	88 = 1" NPT		

## SPECIFICATIONS

ITEM	MODEL	BVCH-18	BVCH-28	BVCH-38	BVCH-48	BVCH-68	BVCH-88
CONNECTION	NPT	1/8"-27	1/4"-18	3/8"-18	1/2"-14	3/4"-14	1"-11.5
OVERALL LENGTH	IN. (mm)	0.67" (17.0)	0.93" (23.5)	1.22" (31.0)	1.41" (34.5)	1.60" (40.5)	1.83" (46.5)
HEX	IN. (mm)	1/2" (12.7)	3/4" (19.0)	7/8" (22.0)	1-1/8" (28.5)	1-1/4" (32.0)	1-1/2" (38.0)
MATERIAL	BODY	BRASS					
	ELEMENT	SINTERED BRONZE (100 micron)					
MAX OPERATING PRESSURE		150 PSI (10.55 kg/cm <sup>2</sup> )					
OPERATING TEMPERATURE		35°F TO 300°F (1.6°C to 149°C)					
WEIGHT (APPROX.)	OZ.	0.38	1.08	1.92	3.30	5.33	7.92
UNIT PACK	EA.	10	10	10	5	5	1

## SPECIFICATIONS

ITEM	MODEL	BVCH-SAE#4	BVCH-SAE#6	BVCH-SAE#8
CONNECTION	SAE	7/16"-20	9/16"-18	3/4"-16
OVERALL LENGTH	IN. (mm)	0.87" (22.0)	1.22" (31.0)	1.36" (34.5)
HEX	IN. (mm)	11/16" (17.5)	7/8" (22.0)	1-1/8" (28.5)
MATERIAL	BODY	BRASS		
	ELEMENT	SINTERED BRONZE (100 micron)		
MAX OPERATING PRESSURE		150 PSI (10.55 kg/cm <sup>2</sup> )		
OPERATING TEMPERATURE		35°F TO 300°F (1.6°C to 149°C)		
WEIGHT (APPROX.)	OZ.	0.88	1.94	3.46
UNIT PACK	EA.	50	50	50

ADSENS TECHNOLOGY, INC.

Toll Free (800) 641-9026 Tel (626) 854-2773 Fax (626) 854-8183 • Email: sales@adsens.net • www.adsens.net

# PGV-Series, Countersink Plug Vent



PGV-Series countersink plug vent is designed to fit flush with the surface while offering free exchange of filtered air vent to atmosphere. These countersink plug vents can be install easily into single acting cylinders, gear boxes, storage tanks or other vessels and valves, whenever pressure equalization is required.

Supplied with standard male pipe thread with internal hex, unit can be easily installed with a hex key with little or no protrusion. Nickel-plated brass body and 40 micron is standard, optional 10 or 90 micron filter element is available.

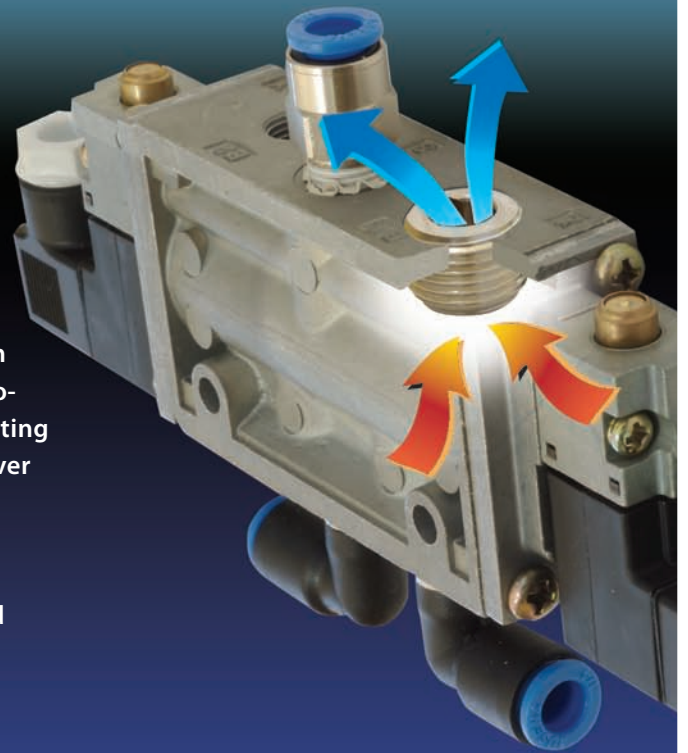

## SYMBOL

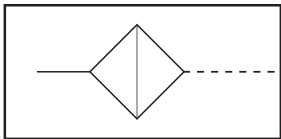

## HOW TO ORDER

**PGV -**  
Breather Vent Plug



Connection

18 = 1/8" NPT

28 = 1/4" NPT

38 = 3/8" NPT

48 = 1/2" NPT

-



Element Porosity

None = 40um (standard)

10 = 10um

90 = 90um

## SPECIFICATIONS

ITEM	MODEL	PGV-18	PGV-28	PGV-38	PGV-48
CONNECTION	NPT	1/8"-27	1/4"-18	3/8"-18	1/2"-14
OVERALL LENGTH	IN. (mm)	0.354" (9.0)	0.472" (12.0)	0.492" (12.5)	0.610" (15.5)
INTERNAL HEX	IN. (mm)	1/4" (6.0)	5/16" (8.0)	3/8" (10.0)	3/8" (10.0)
MATERIAL	BODY	NICKEL PLATED BRASS (Ni-Cu)			
	ELEMENT	SINTERED BRONZE (40 micron)			
MAX OPERATING PRESSURE		150 PSI (10.55 kg/cm <sup>2</sup> )			
OPERATING TEMPERATURE		35° F TO 300° F (1.6° C to 149° C)			
WEIGHT (APPROX.)	OZ.	0.09	0.22	0.39	0.84
UNIT PACK	EA.	10	10	10	5



18310 Bedford Circle, City of Industry, CA 91744-5971  
 Toll Free (800) 641-9026 Tel (626) 854-2773 Fax (626) 854-8183  
 Email: sales@adsens.net • www.adsens.net

# FANTO MUFFLER

HFTO-SERIES



FANTO® mufflers utilize a 50 mesh, self-cleaning stainless steel screen in a strong, yet lightweight aluminum shell so they are completely corrosion-resistant. The large vent holes combined with precisely calculated layers of stainless steel screen is to allow high airflow, but effectively reduce the air exhaust noise level.

Their **ULTRA-SLIM** profile allows the FANTO® mufflers to be installed anywhere space is limited. Install directly to the exhaust ports of pneumatic valves is possible without interference with other ports, since the overall body diameter is barely larger than the corresponding thread diameter.

Unit should be mounted in a protective position free from excessive vibration. Use wrench on hex head to tighten unit to the device.

Symbol

**PATENTED**

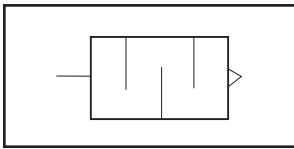

### HOW TO ORDER

**HFTO**

Fanto Muffler

Connection (NPTM)

18=1/8", 28=1/4"

38=3/8", 48=1/2"

68=3/4", 88=1"

### FLOW CHARACTERISTICS - FANTO® MUFFLER

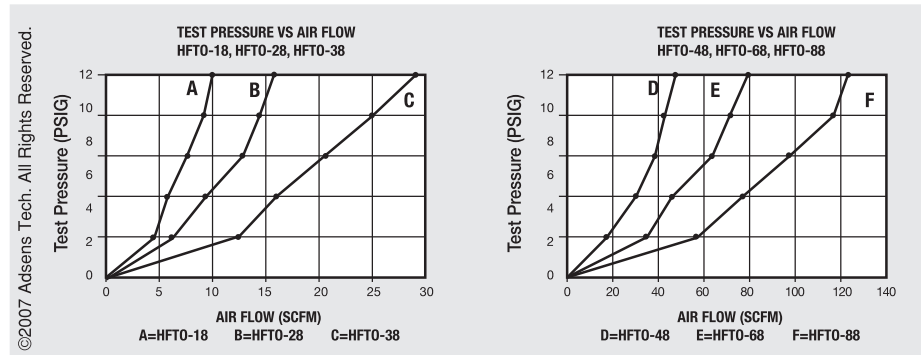

\* All tests are performed by Consolidated Laboratories, Inc.

### SPECIFICATIONS

ITEM	MODEL	HFTO-18	HFTO-28	HFTO-38	HFTO-48	HFTO-68	HFTO-88
CONNECTION	NPTM	1/8"	1/4"	3/8"	1/2"	3/4"	1"
OVERALL LENGTH	IN.	1-7/16"	1-25/32"	2-9/32"	2-25/32"	3-3/16"	3-57/64"
HEX	IN.	7/16"	9/16"	11/16"	7/8"	1-1/16"	1-5/16"
MATERIAL	BODY	ALUMINUM					
	ELEMENT	50 MESH STAINLESS STEEL SCREEN					
MAX OPERATING PRESSURE		300 PSI (21.1 kg/cm <sup>2</sup> )					
OPERATING TEMPERATURE		35°F TO 160°F (1.6°C to 70°C)					
WEIGHT (APPROX.)	OZ.	0.25	0.50	0.90	1.55	2.25	4.20
UNIT PACK	EA.	10	10	5	5	1	1

### SOUND CHARACTERISTICS - FANTO® MUFFLER

BACK PRESSURE (PSIG)	HFTO-18		HFTO-28		HFTO-38		HFTO-48		HFTO-68		HFTO-88	
	FLOW (SCFM)	db	FLOW (SCFM)	db	FLOW (SCFM)	db	FLOW (SCFM)	db	FLOW (SCFM)	db	FLOW (SCFM)	db
2	4.25	73.0	5.97	70.0	12.36	71.5	18.12	70.0	34.11	82.0	55.75	85.5
4	5.86	78.0	9.47	76.5	15.79	77.0	30.45	74.5	43.37	84.5	75.57	86.0
6	7.40	81.5	12.10	80.0	20.17	80.5	35.61	77.0	62.08	84.5	97.69	86.0
8	8.70	83.5	14.20	82.0	24.86	83.5	42.26	78.0	70.85	85.5	115.59	86.5
10	10.10	86.5	16.00	83.5	28.51	86.0	47.95	80.0	80.61	88.0	127.00	85.5

\* All tests are performed by Consolidated Laboratories, Inc.

# HIGH FLOW REPAIRABLE MUFFLER

## HFRAM-SERIES



HFRAM-Series mufflers use strong aluminum housing with polyvinyl foam element. It is compact, light weight and highly effective against noisy exhaust port without excessive back pressure. They are completely non-corrosive and engineered for long service life; cost effective design allows element insert to be easily replaced at the end of its service life, not the entire muffler.

All models are furnished with standard male pipe threads ranging from 1/8" to 1" NPT; unit should be mounted in a protective position free from excessive vibration.

Symbol

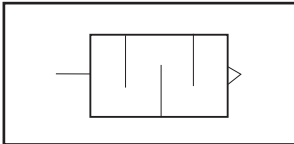

### HOW TO ORDER

**HFRAM** —    
 High Flow                      Connection (NPTM)  
 Repairable Muffler        18=1/8", 28=1/4"  
    38=3/8", 48=1/2"  
    68=3/4", 88=1"

### SPECIFICATIONS

ITEM	MODEL	HFRAM-18	HFRAM-28	HFRAM-38	HFRAM-48	HFRAM-68	HFRAM-88
REPLACEABLE INSERT		PVI-18	PVI-28	PVI-38	PVI-48	PVI-68	PVI-88
FLUID		AIR					
CONNECTION	NPTM	1/8"	1/4"	3/8"	1/2"	3/4"	1"
OVERALL LENGTH	IN.	1-7/16"	1-25/32"	2-9/32"	2-13/16"	3-3/16"	3-15/16"
HEX	IN.	7/16"	9/16"	11/16"	7/8"	1-1/16"	1-5/16"
NOISE ELIMINATION EFFECT	dB	14	16	18	29	34	40
MATERIAL	BODY	ALUMINUM					
	ELEMENT	POLYVINYL FOAM (5 um)					
MAX OPERATING PRESSURE		130 PSI (9 kg/cm <sup>2</sup> )					
OPERATING TEMPERATURE		41°F TO 140°F (5°C to 60°C)					
WEIGHT (APPROX.)	OZ.	0.16	0.32	0.48	0.96	1.20	2.16
UNIT PACK	EA.	10	10	10	5	1	1

# RESIN (POLYETHYLENE) MUFFLER

RM-SERIES



RM-Series mufflers uses rugged polyethylene housing with polyvinyl foam element. It is compact, light weight and highly effective for noise reduction without excessive back pressure. They are completely non-corrosive and highly resistant to water and oil. Elements can be easily cleaned with kerosene or similar cleaning solvent.

All models are furnished with standard male pipe threads range from 1/8" to 1/2" NPT; unit should be mounted in a protective position free from excessive vibration. Hand tighten only.

## Symbol

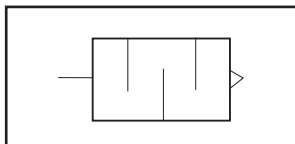

## HOW TO ORDER

**RM**

Resin Muffler



Connection (NPTM)

18=1/8", 28=1/4"

28L=1/4" (High Flow)

38=3/8", 48=1/2"

## SPECIFICATIONS

ITEM	MODEL	RM-18	RM-28	RM-28L	RM-38	RM-48
FLUID		AIR				
CONNECTION	NPTM	1/8"	1/4"		3/8"	1/2"
OVERALL LENGTH	IN.	1-3/8"	1-1/2"	2-7/16"	2-5/8"	2-3/4"
DIAMETER	IN.	5/8"	5/8"	13/16"	1"	1-7/64"
HEX	IN.	9/16"	9/16"	11/16"	1"	1"
EFFECTIVE AREA	Cv	0.813	1.14	2.33	3.52	4.00
NOISE ELIMINATION EFFECT	dB	18	18	18	27	34
MATERIAL	BODY	POLYETHYLENE (PE)				
	ELEMENT	POLYVINYL FOAM (5 um)				
MAX OPERATING PRESSURE		130 PSI (9 kg/cm <sup>2</sup> )				
OPERATING TEMPERATURE		41°F TO 140°F (5°C to 60°C)				
WEIGHT (APPROX.)	OZ.	0.16	0.18	0.42	0.77	0.86
UNIT PACK	EA.	5	5	5	5	5

**WARNING:** Clean mufflers with neutral cleaning agent or cleaning oil, DO NOT use paint thinner, benzene or other organic solvents.

# POLYETHYLENE MUFFLER

PEM-SERIES



Symbol

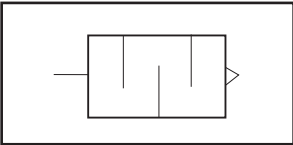

PEM-Series muffler uses high-density porous polyethylene body ultrasonically welded to the solid polyethylene base. It is light weight, durable and highly effective for noise reduction without excessive back pressure. The uniquely structured porous polyethylene channels escaping air through a tortuous path reduce the noise level within OSHA requirements.

The durable porous polyethylene body can withstand high working pressures up to 150 PSI. In an unlikely event of a blowout, resilient porous plastic body will not shatter, therefore no danger of flying fragments. The polyethylene plastic is completely non-corrosive and highly resistant to water and oil usually present in compressed air lines and can be easily cleaned with methylene chloride or similar cleansing fluid.

Available in three (3) air flows:

Standard flow (70 um - black base)

Fine flow (20 um - blue base)

Medium flow (35 um - red base)

Unit should be mounted in a protective position free from excessive vibration. Hand tightens to the device only.

## NOISE ELIMINATION EFFECT

Model Number	Sound Pressure dB(A)		
	Fine Flow 20 um (Blue Base)	Medium Flow 35 um (Red Base)	Standard Flow 70 um (Black Base)
PEM-18 (1/8")	80	85	90
PEM-18 (1/4")	77	80	88
PEM-18 (3/8")	80	81	86
PEM-18 (1/2")	77	82	85
PEM-18 (3/4")	81	81	85
PEM-18 (1")	78.5	82	84

Inlet Pressure: 125 PSI

## HOW TO ORDER

**PEM**

Polyethylene  
Muffler



Connection (NPTM)

18=1/8", 28=1/4"  
38=3/8", 48=1/2"  
68=3/4", 88=1"



Element Porosity

None=Standard flow (70 um)  
20=Fine flow (20 um)  
35=Medium flow (35 um)

## SPECIFICATION

ITEM	MODEL	PEM-18	PEM-28	PEM-38	PEM-48	PEM-68	PEM-88
CONNECTION	NPTM	1/8"	1/4"	3/8"	1/2"	3/4"	1"
OVERALL LENGTH	IN.	1-15/32" (37mm)	1-3/4" (44mm)	2-13/16" (71mm)	3-5/32" (80mm)	5-1/4" (133mm)	5-3/32" (129mm)
DIAMETER		5/8" (15.6mm)	51/64" (20mm)	1" (26mm)	1" (26mm)	1-1/2" (38mm)	2" (50mm)
MATERIAL	BODY	POLYETHYLENE (PE)					
	ELEMENT	POLYETHYLENE (PE)					
MAX OPERATING PRESSURE		150 PSI (10.5 kg/cm <sup>2</sup> )					
OPERATING TEMPERATURE		41°F TO 140°F (5°C to 60°C)					
WEIGHT (APPROX.)	OZ.	0.10	0.15	0.36	0.41	1.34	2.22
UNIT PACK	EA.	5	5	5	5	5	5

# HIGH FLOW STEEL MUFFLER

HFSM-SERIES



HFSM-Series steel mufflers utilize a 50 mesh, self-cleaning STAINLESS STEEL SCREEN in a tough steel shell to withstand shock and continuous heavy duty use in all applications.

Designed with evenly distributed small holes around the steel shell, exhaust air quietly disperses over a 360 degree pattern without restricting air flow. Their SLIM profile allows them to be installed anywhere space is limited. Install directly to the exhaust ports of pneumatic valves, or closely spaced manifold ports is possible without interference with other ports.

Unit should be mounted in a protective position free from excessive vibration. Use wrench on hex head to tighten unit to the exhaust ports of air-operated equipment.

Symbol

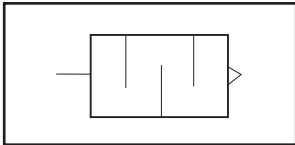

## FLOW CHARACTERISTICS - HIGH FLOW STEEL MUFFLER

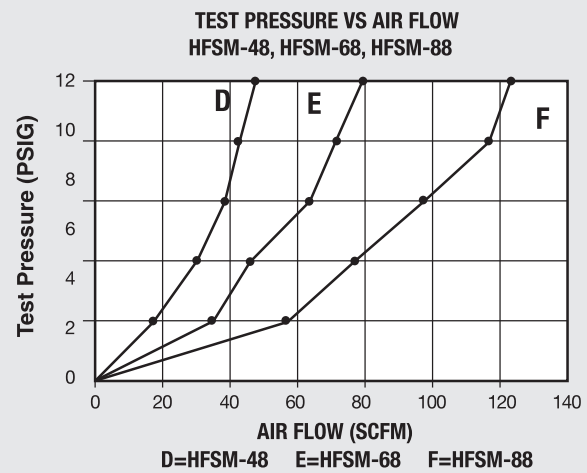
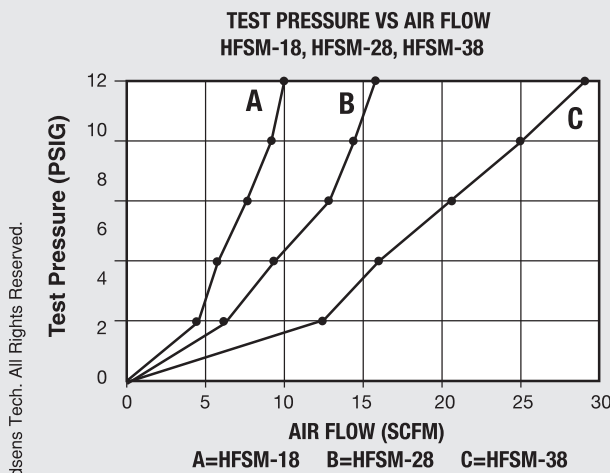

\* All tests are performed by Consolidated Laboratories, Inc.

## SOUND CHARACTERISTICS - STEEL MUFFLER

BACK PRESSURE (PSIG)	HFSM-18		HFSM-28		HFSM-38		HFSM-48		HFSM-68		HFSM-88	
	FLOW (SCFM)	db	FLOW (SCFM)	db	FLOW (SCFM)	db	FLOW (SCFM)	db	FLOW (SCFM)	db	FLOW (SCFM)	db
2	4.25	73.0	5.97	70.0	12.36	71.5	18.12	70.0	34.11	82.0	55.75	85.5
4	5.86	78.0	9.47	76.5	15.79	77.0	30.45	74.5	43.37	84.5	75.57	86.0
6	7.40	81.5	12.10	80.0	20.17	80.5	35.61	77.0	62.08	84.5	97.69	86.0
8	8.70	83.5	14.20	82.0	24.86	83.5	42.26	78.0	70.85	85.5	115.59	86.5
10	10.10	86.5	16.00	83.5	28.51	86.0	47.95	80.0	80.61	88.0	127.00	85.5

\* All tests are performed by Consolidated Laboratories, Inc.

# HIGH FLOW STEEL MUFFLER

HFSM SERIES

## HOW TO ORDER

**HFSM** —

High Flow Steel Muffler

Connection (NPTM)

Port Option

18=1/8", 28=1/4"

None=NPT

38=3/8", 48=1/2"

P=BSPT

68=3/4", 88=1"

128=1-1/4", 148=1-1/2"

200=2"

## SPECIFICATIONS

ITEM	MODEL	HFSM-18	HFSM-28	HFSM-38	HFSM-48	HFSM-68	HFSM-88	HFSM-128	HFSM-148	HFSM-200
CONNECTION	NPTM	1/8"	1/4"	3/8"	1/2"	3/4"	1"	1-1/4"	1-1/2"	2"
OVERALL LENGTH	IN.	1-5/16"	1-11/16"	2-7/64"	2-41/64"	3-15/64"	3-25/32"	4-27/64"	4-15/16"	5-19/32"
HEX	IN.	7/16"	9/16"	11/16"	7/8"	1-1/16"	1-5/16"	1-11/16"	2"	2-3/8"
MATERIAL	BODY	STEEL (ZINC PLATED)								
	ELEMENT	50 MESH STAINLESS STEEL SCREEN								
MAX OPERATING PRESSURE		300 PSI (21.1 kg/cm <sup>2</sup> )								
OPERATING TEMPERATURE		35°F TO 160°F (1.6°C TO 70°C)								
WEIGHT (APPROX.)	OZ.	0.25	0.50	0.90	1.55	2.25	4.20	11.7	17.3	25.2
UNIT PACK	EA.	10	10	5	5	1	1	1	1	1

## HOW TO ORDER

**FHFSM** —

Female High Flow  
Steel Muffler

Connection(NPTF)

18=1/8", 28=1/4"

38=3/8", 48=1/2"

## SPECIFICATIONS

ITEM	MODEL	FHFSM-18	FHFSM-28	FHFSM-38	FHFSM-48
CONNECTION	NPTF	1/8"	1/4"	3/8"	1/2"
OVERALL LENGTH	IN.	1-45/64"	2-13/64"	2-23/32"	3-7/32"
HEX	IN.	9/16"	11/16"	7/8"	1-1/16"
MATERIAL	BODY	STEEL (ZINC PLATED)			
	ELEMENT	50 MESH STAINLESS STEEL SCREEN			
MAX OPERATING PRESSURE		300 PSI (21.1 kg/cm <sup>2</sup> )			
OPERATING TEMPERATURE		35°F TO 160°F (1.6°C TO 70°C)			
WEIGHT (APPROX.)	OZ.	0.80	1.55	2.65	4.60
UNIT PACK	EA.	10	10	5	5

## HOW TO ORDER

**HFSS** —

High Flow  
Stainless Steel Muffler

Connection (NPTM)

18=1/8", 28=1/4"

38=3/8", 48=1/2"

68=3/4", 88=1"

## SPECIFICATIONS

ITEM	MODEL	HFSS-18	HFSS-28	HFSS-38	HFSS-48	HFSS-68	HFSS-88
CONNECTION	NPTM	1/8"	1/4"	3/8"	1/2"	3/4"	1"
OVERALL LENGTH	IN.	1-3/8"	1-11/16"	2-7/64"	2-41/64"	3-15/64"	3-25/32"
HEX	IN.	7/16"	9/16"	11/16"	7/8"	1-1/16"	1-5/16"
MATERIAL	BODY	314 GRADE STAINLESS STEEL					
	ELEMENT	50 MESH STAINLESS STEEL SCREEN					
MAX OPERATING PRESSURE		300 PSI (21.1 kg/cm <sup>2</sup> )					
OPERATING TEMPERATURE		35°F TO 160°F (1.6°C TO 70°C)					
WEIGHT (APPROX.)	OZ.	0.32	0.72	1.20	2.40	4.10	7.00
UNIT PACK	EA.	10	10	5	5	1	1



# HIGH FLOW MUFFLER

HFMA-SERIES



HFMA-Series high flow muffler features a 50 mesh, self-cleaning stainless steel screen, and combined with corrosion-resistant aluminum shell to create a highly efficient, ultra-quiet muffler designed with minimal back pressure.

When installed on the exhaust ports of pneumatic valves or manifolds, the aluminum body mufflers provides a quick and inexpensive way to reduce work area noise while preventing contamination from entering into the inside of the pneumatic valves.

Unit should be mounted in a protective position free from excessive vibration. Use wrench on flats to tighten unit to the device.

Symbol

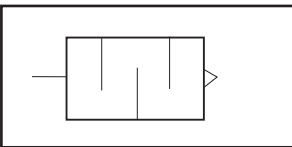

## HOW TO ORDER

<b>HFMA</b>	—	<input type="checkbox"/>	<input type="checkbox"/>	<input type="checkbox"/>
High Flow Muffler		<b>Connection (NPTM)</b>		<b>Port Option</b>
Aluminum Body		18=1/8", 28=1/4"		None = NPT
		38=3/8", 48=1/2"		P = BSPT
		68=3/4", 88=1"		

## SPECIFICATIONS

ITEM	MODEL	HFMA-18	HFMA-28	HFMA-38	HFMA-48	HFMA-68	HFMA-88
CONNECTION	NPTM	1/8"	1/4"	3/8"	1/2"	3/4"	1"
OVERALL LENGTH	IN.	1-7/8"	1-7/8"	3-5/16"	3-5/16"	4-9/16"	4-9/16"
DIAMETER	IN.	13/16"	13/16"	1-1/4"	1-1/4"	2"	2"
FLATS	IN.	5/8"	5/8"	1"	1"	1-5/8"	1-5/8"
MATERIAL	BODY	ALUMINUM					
	ELEMENT	50 MESH STAINLESS STEEL SCREEN					
MAX OPERATING PRESSURE		300 PSI (21.1 kg/cm <sup>2</sup> )					
OPERATING TEMPERATURE		35°F TO 160°F (1.6°C to 70°C)					
WEIGHT (APPROX.)	OZ.	0.52	0.52	1.81	1.83	5.2	5.52
UNIT PACK	EA.	5	5	5	5	1	1

## FLOW CHARACTERISTICS

BACK PRESSURE VS. AIR FLOW

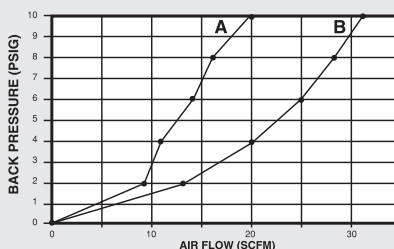

A = HFMA-18 / HFMP-18  
B = HFMA-28 / HFMP-28

BACK PRESSURE VS. AIR FLOW

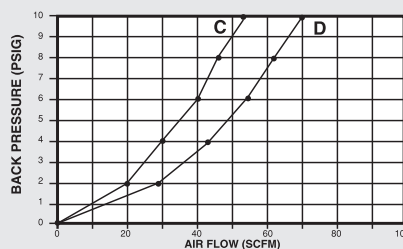

C = HFMA-38/ HFMP-38  
D = HFMA-48/ HFMP-48

BACK PRESSURE VS. AIR FLOW

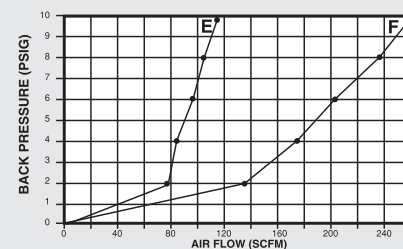

E = HFMA-68  
F = HFMA-88

# HIGH FLOW MUFFLER

HFMP-SERIES



Built with the same concepts as our popular HFMA-Series but more affordable, our HFMP-Series utilize glass-filled nylon housing which is ultrasonically welded for maximum strength.

Both HFMA and HFMP Series offers greater flow with less pressure drop than the BM-Series, while lowering noise levels. Please refer to the sound and flow characteristics charts listed below for more information. Unit should be mounted in a protective position free from excessive vibration. Hand tighten to the device only.

## Symbol

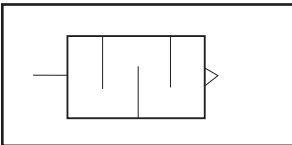

## HOW TO ORDER

### HFMP

High Flow Muffler  
Plastic Body

—    
**Connection (NPTM)**  
18=1/8", 28=1/4"  
38=3/8", 48=1/2"

—   
**Port Option**  
None=NPT  
P=BSPT

**Housing Color**  
None=Black  
Y=Yellow

## SPECIFICATIONS

ITEM	MODEL	HFMP-18	HFMP-28	HFMP-38	HFMP-48
CONNECTION	NPTM	1/8"	1/4"	3/8"	1/2"
OVERALL LENGTH	IN.	2-1/8"	2-7/32"	3-7/16"	3-7/16"
DIAMETER	IN.	53/64"	53/64"	1-1/4"	1-1/4"
HEX	IN.	11/16"	11/16"	1-5/32"	1-5/32"
MATERIAL	BODY	NYLON			
	ELEMENT	50 MESH STAINLESS STEEL SCREEN			
MAX OPERATING PRESSURE		150 PSI (10.55 kg/cm <sup>2</sup> )			
OPERATING TEMPERATURE		35° F TO 120° F (1.6° C to 50° C)			
WEIGHT (APPROX.)	OZ.	0.40	0.48	1.60	1.60
UNIT PACK	EA.	5	5	5	5

## SOUND CHARACTERISTICS

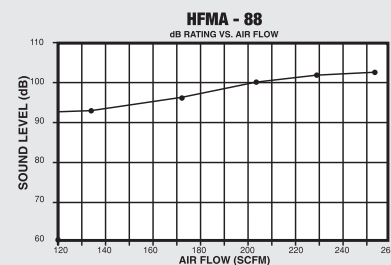
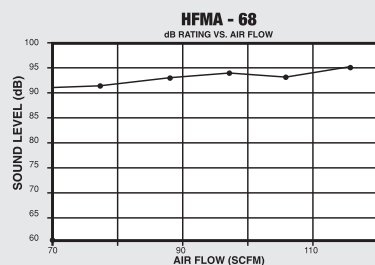
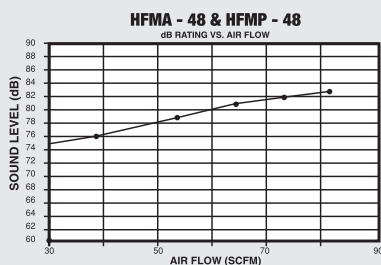
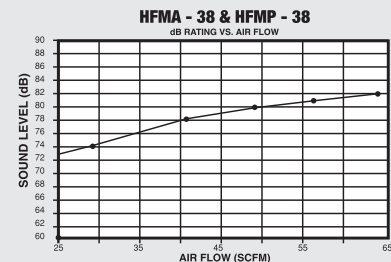
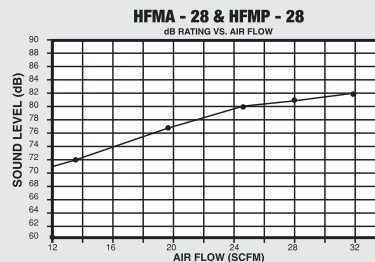
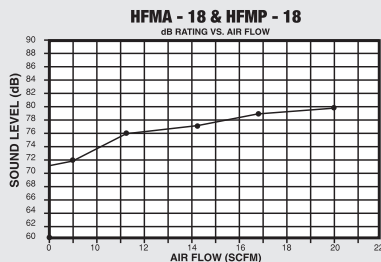

# PNEUMATIC EXHAUST MUFFLER

**BM-SERIES**



Symbol

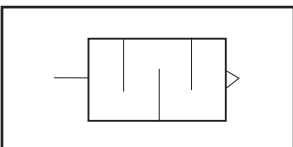

BM-Series mufflers utilize porous sintered bronze filter element secured to standard pipe fittings. These compact and inexpensive mufflers are easy to install and maintain, particularly suitable where space is limited. They are used to diffuse air and muffle noise from the exhaust ports of air valves, air cylinders and air tools to an acceptable level within OSHA noise requirements.

BM-Series mufflers can also be used as filters for gasoline, oil and air exhaust and intake filtering; coalescing of oil mist or water vapor; cryogenic phase separation; pressure of vacuum equalization and many others.

Unit should be mounted in a protective position free from excessive vibration. Use wrench on hex head to tighten unit to the device. Standard unit contains a 40 micron element, and 10 or 90 micron units are available on special order.

## HOW TO ORDER

**BM** —

**Bronze Muffler**      **Connection (NPTM)**      **Port Option**

08=10-32 UNF,    18=1/8"      None=NPT  
 28=1/4",        38=3/8"      P=BSPT  
 48=1/2",        68=3/4"      G=BSPP  
 88=1",           128=1-1/4"  
 148=1-1/2"

### FLOW CHARACTERISTICS - PNEUMATIC EXHAUST MUFFLER

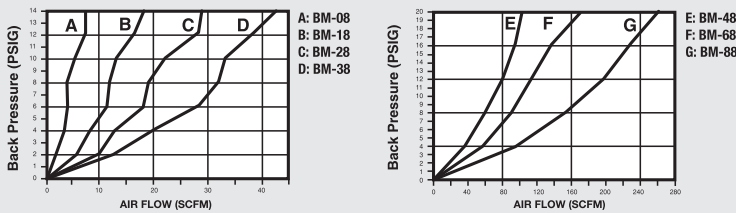

©2007 Adsens Tech. All Rights Reserved.

## SPECIFICATIONS

ITEM	MODEL	BM-08	BM-18	BM-28	BM-38	BM-48	BM-68	BM-88	BM-128	BM-148
CONNECTION	NPTM	10-32UNF	1/8"	1/4"	3/8"	1/2"	3/4"	1"	1-1/4"	1-1/2"
OVERALL LENGTH	IN.	3/4"	29/32"	1-5/16"	1-9/16"	1-7/8"	2-9/32"	2-57/64"	3-7/16"	4"
HEX	IN.	5/16"	7/16"	9/16"	11/16"	7/8"	1-9/64"	1-11/32"	1-3/4"	2"
MATERIAL	BODY	BRASS								
	ELEMENT									
MAX OPERATING PRESSURE		300 PSI (21.1 kg/cm <sup>2</sup> )								
OPERATION TEMPERATURE		35°F TO 300°F (1.6°C to 149°C)								
WEIGHT (APPROX.)	Oz.	0.16	0.26	0.56	0.93	1.47	2.96	4.16	9.5	13.75
UNIT PACK	EA.	10	10	10	10	5	1	1	1	1

## SOUND CHARACTERISTICS - PNEUMATIC EXHAUST MUFFLER

BACK PRESSURE (PSIG)	BM-08		BM-18		BM-28		BM-38		BM-48		BM-68		BM-88	
	FLOW (SCFM)	db	FLOW (SCFM)	db	FLOW (SCFM)	db	FLOW (SCFM)	db	FLOW (SCFM)	db	FLOW (SCFM)	db	FLOW (SCFM)	db
2	1.1	72	7	72	10	73	12	74	26.6	75	39.4	76	67	93
4	2.3	72	9	73	12	74	20	74	39.5	76	62.0	80	104	95
6	3.6	72	11	73	17	74	26	74	49.9	77	80.7	88	134	97
8	5.0	73	12	73	19	74	31	75	60.9	80	97.0	93	154	100
10	5.2	73	13	74	23	75	35	76	71.3	86	110.2	96	181	101
12	7.4	74	15	74	23	75	39	76	79.5	87	121.3	97	210	102
14	8.0	74	17	75	29	76	43	77	86.6	90	136.9	98	231	105
16	---	---	---	---	---	---	---	---	93.9	92	144.5	99	231	105
18	---	---	---	---	---	---	---	---	102.8	95	160.9	100	246	105
20	---	---	---	---	---	---	---	---	107.5	95	169.1	100	261	105

©2007 Adsens Tech. All Rights Reserved.

# PNEUMATIC EXHAUST MUFFLER

**BM-SERIES**

## HOW TO ORDER

**BMS** —    —

**Bronze Muffler**      Connection (NPTM)      Port Option      Finish

18=1/8"    28=1/4"      None=NPT      None=Ni-Fe Fitting/Bronze Element  
 38=3/8", 48=1/2"      P=BSPT      NP= Completed nickel plated  
 68=3/4", 88=1"      (Element and Fitting)  
 128=1-1/4", 148=1-1/2"  
 200=2"

## SPECIFICATIONS

ITEM	MODEL	BMS-18	BMS-28	BMS-38	BMS-48	BMS-68	BMS-88	BMS-128	BMS-148	BMS-200
CONNECTION	NPTM	1/8"	1/4"	3/8"	1/2"	3/4"	1"	1-1/4"	1-1/2"	2"
OVERALL LENGTH	IN.	29/32"	1-5/16"	1-9/16"	1-7/8"	2-9/32"	2-57/64"	3-7/16"	4"	4-3/4"
HEX	IN.	7/16"	9/16"	11/16"	7/8"	1-9/64"	1-11/32"	1-3/4"	2"	2-3/8"
MATERIAL	BODY	NICKEL-PLATED IRON (Ni-Fe)								
	ELEMENT	SINTERED BRONZE (40 micron standard, also available in 10 or 90 micron)								
MAX OPERATING PRESSURE		300 PSI (21.1 kg/cm <sup>2</sup> )								
OPERATION TEMPERATURE		35°F TO 300°F (1.6°C to 149°C)								
WEIGHT (APPROX.)	OZ.	0.26	0.53	0.91	1.6	2.96	4.48	9.5	13.12	17.6
UNIT PACK	EA.	10	10	10	5	1	1	1	1	1

## HOW TO ORDER

**FBMS** —

**Female Bronze Muffler**      Connection (NPTF)

18=1/8", 28=1/4"  
 38=3/8", 48=1/2"

## SPECIFICATIONS

ITEM	MODEL	FBMS-18	FBMS-28	FBMS-38	FBMS-48
CONNECTION	NPTF	1/8"	1/4"	3/8"	1/2"
OVERALL LENGTH	IN.	1-5/16"	1-37/64"	1-57/64"	2-9/16"
HEX	IN.	9/16"	11/16"	7/8"	1-1/16"
MATERIAL	BODY	NICKEL-PLATED IRON (Ni-Fe)			
	ELEMENT	SINTERED BRONZE (40 micron)			
MAX OPERATING PRESSURE		300 PSI (21.1 kg/cm <sup>2</sup> )			
OPERATING TEMPERATURE		35°F TO 300°F (1.6°C to 149°C)			
WEIGHT (APPROX.)	OZ.	0.71	1.2	2.08	4.44
UNIT PACK	EA.	5	5	5	5

## HOW TO ORDER

**BM — SAE#**

**Bronze Muffler**      Connection (SAE)

4=7/16"-20  
 6=9/16"-18  
 8=3/4"-16

## SPECIFICATIONS

ITEM	MODEL	BM-SAE#4	BM-SAE#6	BM-SAE#8
CONNECTION	SAE	7/16"-20	9/16"-18	3/4"-16
OVERALL LENGTH	IN.	1-11/32"	1-17/32"	1-55/64"
HEX	IN.	9/16"	11/16"	7/8"
MATERIAL	BODY	BRASS		
	ELEMENT	SINTERED BRONZE (40 micron)		
MAX OPERATING PRESSURE		300 PSI (21.1 kg/cm <sup>2</sup> )		
OPERATING TEMPERATURE		35°F TO 300°F (1.6°C to 149°C)		
WEIGHT (APPROX.)	OZ.	0.60	0.95	1.55
UNIT PACK	EA.	50	50	50

# BREATHER VENT

**BVS-SERIES**



BV-Series low profile breather vents have many applications. They are most often used on single acting cylinders or valves to prevent dirt and foreign particles from entering ports open to the atmosphere. Common uses can also be found on vacuum relief or pressure equalization for gear boxes, crank cases, storage tanks or other vessels whenever pressure equalization is required.

Supplied with standard male pipe threads, they can be installed, with little protrusion, as a flat integral part of the equipment. Unit should be mounted in a protective position from excessive vibration. Use wrench on hex head to tighten unit to the device. The filter element used in the standard breather vent is rated for 40 micron filtration, optional 10 or 90 micron is available upon request.

## Symbol

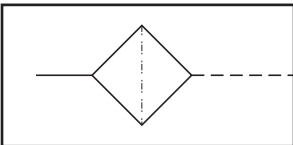

## HOW TO ORDER

**BVS** —    —

<b>Breather Vent</b>	<b>Connection (NPTM)</b>	<b>Port Option</b>	<b>Finish</b>
	18=1/8", 28=1/4"	None=NPT	None=Ni-Fe Fitting/Bronze Element
	38=3/8", 48=1/2"	P = BSPT	NP=Completely Nickel plated
	68=3/4", 88=1"		(Element + Fitting)
	128=1-1/4",		
	148=1-1/2"		

## SPECIFICATIONS

ITEM	MODEL	BVS-18	BVS-28	BVS-38	BVS-48	BVS-68	BVS-88	BVS-128	BVS-148
CONNECTION	NPTM	1/8"	1/4"	3/8"	1/2"	3/4"	1"	1-1/4"	1-1/2"
OVERALL LENGTH	IN.	1/2"	11/16"	27/32"	61/64"	1-7/64"	1-11/32"	1-9/16"	1-5/8"
HEX	IN.	7/16"	9/16"	11/16"	7/8"	1-9/64"	1-11/32"	1-3/4"	2"
MATERIAL	BODY	NICKEL-PLATED IRON (Ni-Fe)							
	ELEMENT	SINTERED BRONZE (40 micron Standard, 10 or 90 micron available)							
MAX OPERATING PRESSURE		150 PSI (10.55 kg/cm <sup>2</sup> )							
OPERATING TEMPERATURE		35°F TO 300°F (1.6°C to 149°C)							
WEIGHT (APPROX.)	OZ.	0.19	0.39	0.70	1.17	1.84	3.31	7.25	9.05
UNIT PACK	EA.	10	10	10	10	5	1	1	1

\* SUPPLY WITH GASKET.

## HOW TO ORDER

**FBVS** —

**Female Breather Vent** **Connection (NPTF)**

18=1/8", 28=1/4"  
38=3/8", 48=1/2"

## SPECIFICATIONS

ITEM	MODEL	FBVS-18	FBVS-28	FBVS-38	FBVS-48
CONNECTION	NPTF	1/8"	1/4"	3/8"	1/2"
OVERALL LENGTH	IN.	11/16"	13/16"	31/32"	1-11/64"
HEX	IN.	9/16"	11/16"	7/8"	1-9/16"
MATERIAL	BODY	NICKEL-PLATED IRON (Ni-Fe)			
	ELEMENT	SINTERED BRONZE (40 micron Standard, 10 or 90 micron available)			
MAX OPERATING PRESSURE		150 PSI (10.55 kg/cm <sup>2</sup> )			
OPERATING TEMPERATURE		35°F TO 300°F (1.6°C to 149°C)			
WEIGHT (APPROX.)	OZ.	0.56	0.98	1.70	3.81
UNIT PACK	EA.	5	5	5	5

# BREATHER VENT

BV-SERIES



## HOW TO ORDER

**BV** —    —

Breather Vent	<u>Connection (NPTM)</u>	<u>Port Option</u>	<u>Element Porosity</u>
	08=10-32, 18=1/8"	None=NPT	None=40um (Standard)
	28=1/4", 38=3/8"	P = BSPT	10=10um
	48=1/2", 68=3/4"	G=BSPP	90=90um
	88=1", 128=1-1/4"		
	148=1-1/2"		

## SPECIFICATIONS

ITEM	MODEL	BV-08*	BV-18	BV-28	BV-38	BV-48	BV-68	BV-88	BV-128	BV-148
CONNECTION	NPTM	10-32UNF	1/8"	1/4"	3/8"	1/2"	3/4"	1"	1-1/4"	1-1/2"
OVERALL LENGTH	IN.	23/64"	1/2"	11/16"	27/32"	6164"	1-7/64"	1-11/32"	1-9/16"	1-5/8"
HEX	IN.	5/16"	7/16"	9/16"	11/16"	7/8"	1-9/64"	1-11/32"	1-3/4"	2"
MATERIAL	BODY	BRASS								
	ELEMENT									
MAX OPERATING PRESSURE		150 PSI (10.55 kg/cm <sup>2</sup> )								
OPERATING TEMPERATURE		35°F TO 300°F (1.6°C to 149°C)								
WEIGHT (APPROX.)	OZ.	0.07	0.19	0.39	0.70	1.17	1.84	3.31	7.25	9.05
UNITPACK	EA.	10	10	10	10	10	5	1	1	1

\* SUPPLY WITH GASKET.



## HOW TO ORDER

**BV** — **SAE#**

Breather Vent	<u>Connection (SAE)</u>
	4=7/16"-20, 6=9/16"-18
	8=3/4"-16, 10=7/8"-14
	12=1-1/16"-12

## SPECIFICATIONS

ITEM	MODEL	BV-SAE#4	BV-SAE#6	BV-SAE#8	BV-SAE#10	BV-SAE#12
CONNECTION	SAE	7/16"-20	9/16"-18	3/4"-16	7/8"-14	1-1/16"-12
OVERALL LENGTH	IN.	47/64"	13/16"	15/16"	1-5/32"	1-3/8"
HEX	IN.	9/16"	11/16"	7/8"	1-5/32"	1-11/32"
MATERIAL	BODY	BRASS				
	ELEMENT					
MAX OPERATING PRESSURE		150 PSI (10.55 kg/cm <sup>2</sup> )				
OPERATING TEMPERATURE		35°F TO 300°F (1.6°C to 149°C)				
WEIGHT (APPROX.)	OZ.	0.42	0.71	1.18	2.30	3.90
UNIT PACK	EA.	50	50	50	50	50

# SPEED CONTROL MUFFLER

SCM-SERIES



SCM-Series muffler with speed control provides infinite variation of control of air flow at an acceptable sound level on the exhaust ports of air valves with complete safety.

An external adjustment screw accurately varies orifice opening from closed to full flow as required. The final position is then locked in place by the lock nut. Objectionable exhaust air noise is eliminated by the surrounding sleeve of sintered bronze.

SCM-Series mufflers feature complete safety in operation. The sintered bronze sleeve is held securely in position and protected by an integral shroud.

Standard pipe thread connections provide easy attachment to equipment. Unit should be mounted in a protective position, free from excessive vibration. Use wrench on hex head to tighten unit to the device. Unit contains a 40 micron element.

## Symbol

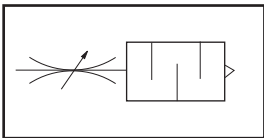

## HOW TO ORDER

<b>SCM</b>	—	□	□	□
Speed Control Muffler		<u>Connection (NPTM)</u>		<u>Port Option</u>
		08=10-32UNF		None=NPT
		18=1/8", 28=1/4"		P = BSPT
		38=3/8", 48=1/2"		G = BSPP
		68=3/4", 88=1"		

## SPECIFICATIONS

ITEM	MODEL	SCM-08	SCM-18	SCM-28	SCM-38	SCM-48	SCM-68	SCM-88
CONNECTION	NPTM	10-32UNF	1/8"	1/4"	3/8"	1/2"	3/4"	1"
MAX. ADJUSTMENT FLOW	SCFM	10	30	50	70	100	130	160
APPROX. HEIGHT (FULL OPEN)	IN.	23/32"	1-1/2"	1-11/16"	1-11/16"	2"	2-3/4"	3"
HEX	IN.	5/16"	1/2"	9/16"	11/16"	7/8"	1-7/64"	1-11/32"
MATERIAL	BODY	BRASS						
	ELEMENT	SINTERED BRONZE (40 micron)						
MAX OPERATING PRESSURE		150 PSI	300 PSI (21.1 kg/cm <sup>2</sup> )					
OPERATING TEMPERATURE		35°F TO 300°F (1.6°C to 149°C)						
WEIGHT (APPROX.)	OZ.	0.18	0.65	1.12	1.73	2.95	4.72	7.57
UNIT PACK	EA.	10	10	10	10	5	1	1

## SOUND CHARACTERISTICS VS. ADJUSTMENT - SPEED CONTROL MUFFLER

INLET PRESSURE=100 PSIG

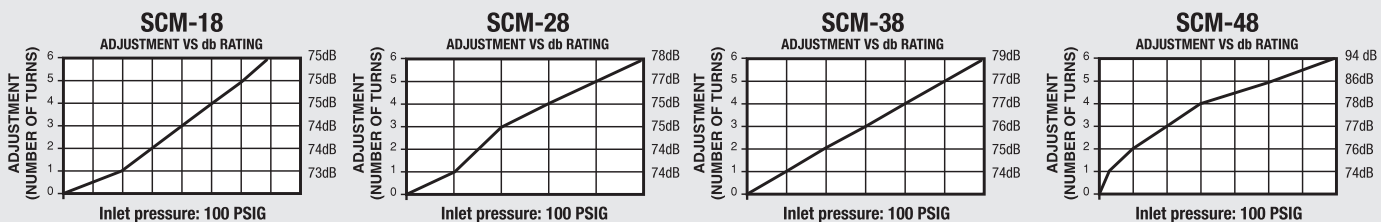

## FLOW CHARACTERISTICS VS. ADJUSTMENT-SPEED CONTROL MUFFLERS

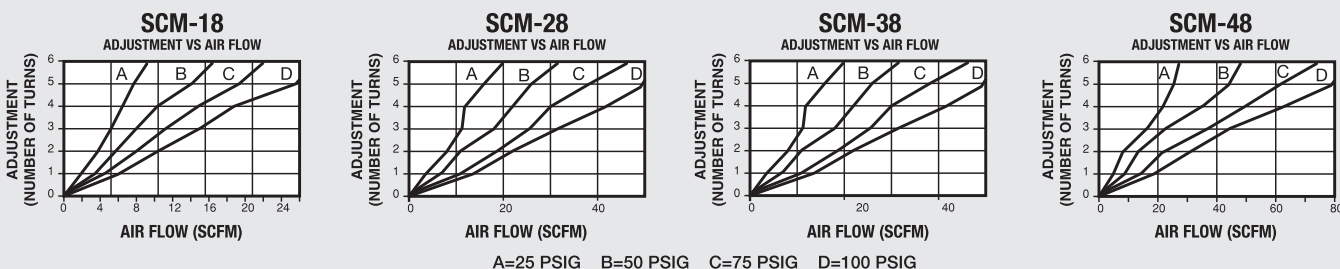

# SPBMS MUFFLER *with flow adjustment*

**SPBMS-SERIES**



SPBMS -Series mufflers utilize our very popular BMS-Series mufflers modified to fit with an external flow adjustment screw.

The external flow adjustment screw accurately varies orifice opening from closed to full flow as required. The final position is then locked in place by the lock nut.

Unit should be mounted in a protective position free from excessive vibration. Use wrench on hex head to tighten unit to the device. All units contain 40-micron filter element.

## Symbol

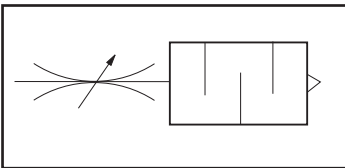

## HOW TO ORDER

**SPBMS** —

Speed Control BMS    **Connection (NPTM)**  
 18=1/8", 28=1/4"  
 38=3/8", 48=1/2"

## SPECIFICATIONS

ITEM	MODEL	SPBMS-18	SPBMS-28	SPBMS-38	SPBMS-48
CONNECTION	NPTM	1/8"	1/4"	3/8"	1/2"
OVERALL LENGTH	IN.	1-37/64"	2-3/32"	2-33/64"	3-1/32"
HEX	IN.	7/16"	9/16"	11/16"	7/8"
MATERIAL	BODY	NICKEL - PLATED IRON (Ni-Fe)			
	ELEMENT	SINTERED BRONZE (40 um)			
	ADJUSTMENT SCREW	NICKEL - PLATED IRON (Ni-Fe)			
	LOCK NUT	NICKEL - PLATED IRON (Ni-Fe)			
MAX OPERATING PRESSURE		300 PSI (21.1 kg/cm <sup>2</sup> )			
OPERATING TEMPERATURE		35°F TO 300°F (1.6°C to 149°C)			
WEIGHT (APPROX.)	OZ.	0.40	0.80	1.52	2.48
UNIT PACK	EA.	5	5	5	5



# STAINLESS STEEL EXHAUST MUFFLER

SSBM-SERIES



SSBM-Series mufflers are constructed with 300-Series stainless steel materials, they are resistant to atmospheric corrosion, foodstuffs, sterilizing solutions, many organic chemicals, dyestuffs and a wide variety of inorganic chemicals.

These compact mufflers are furnished with standard male pipe thread connection, they are easy to install and maintain, particularly suitable for confined area. They are used to diffuse air and muffle noise from the exhaust ports of air valves, air cylinders and air tools to an acceptable level within OSHA noise requirement.

SSBM-Series mufflers can also be used as filters for gasoline, various chemical solutions, oil and air exhaust and intake filtering, coalescing of oil mist or water vapor, etc.; cryogenic phase separation; pressure of vacuum equalization and many others.

Unit should be mounted in a protective position free from excessive vibration. Use wrench on hex head to tighten unit to the device. All units contain 70-micron filter element.

Symbol

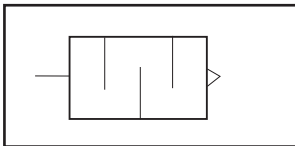

## HOW TO ORDER SSBM

Stainless Steel  
Exhaust Muffler

Connection (NPTM)

08=10-32UNF, 18=1/8"  
28=1/4", 38=3/8"  
48=1/2", 68=3/4"  
88=1"

## FLOW CHARACTERISTICS - S.S. EXHAUST MUFFLER

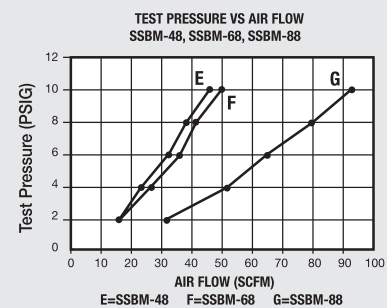
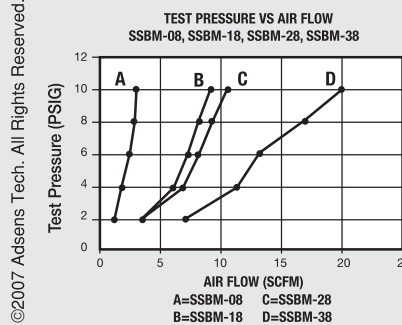

\* All tests are performed by Consolidated Laboratories, Inc.

## SPECIFICATIONS

ITEM	MODEL	SSBM-08	SSBM-18	SSBM-28	SSBM-38	SSBM-48	SSBM-68	SSBM-88
CONNECTION	NPTM	10-32 UNF	1/8"	1/4"	3/8"	1/2"	3/4"	1"
OVERALL LENGTH	IN.	23/32"	1-3/32"	1-3/8"	1-7/8"	2-1/4"	2-51/64"	3-11/64"
HEX	IN.	5/16"	1/2"	5/8"	3/4"	15/16"	1-1/8"	1-1/2"
MATERIAL	BODY	303 GRADE STAINLESS STEEL						
	ELEMENT	316 GRADE STAINLESS STEEL (70 um)						
MAX OPERATING PRESSURE		300 PSI (21.1 kg/cm <sup>2</sup> )						
OPERATING TEMPERATURE		35°F TO 392°F (1.6°C to 200°C)						
WEIGHT (APPROX.)	OZ.	0.13	0.44	0.83	1.34	2.13	3.72	6.32
UNIT PACK	EA.	5	5	5	2	2	1	1

## SOUND CHARACTERISTICS - STAINLESS STEEL EXHAUST MUFFLER

BACK PRESSURE (PSIG)	SSBM-08			SSBM-18		SSBM-28		SSBM-38		SSBM-48		SSBM-68		SSBM-88	
	FLOW (SCFM)	db		FLOW (SCFM)	db	FLOW (SCFM)	db	FLOW (SCFM)	db	FLOW (SCFM)	db	FLOW (SCFM)	db	FLOW (SCFM)	db
2	0.9	60.0		3.4	60.0	3.4	60.5	7.0	60.0	15.0	60.0	15.0	64.0	31.0	68.0
4	1.2	60.0		5.2	60.5	5.4	61.5	11.0	60.5	24.0	62.0	25.0	65.0	51.0	75.0
6	1.7	60.0		6.8	61.0	7.1	62.0	13.0	61.0	31.0	63.5	32.0	66.0	65.0	79.0
8	1.9	60.0		8.1	61.5	8.7	62.5	17.0	62.0	38.5	65.5	40.0	67.0	79.5	81.0
10	2.2	60.0		9.5	62.0	10.4	63.0	20.0	62.5	45.0	67.0	50.0	67.5	93.0	82.5

\* All tests are performed by Consolidated Laboratories, Inc.

# STAINLESS STEEL BREATHER VENT

SSBV-SERIES



SSBV-Series low profile breather vents are constructed with 300-Series stainless steel materials, they are resistant to atmospheric corrosion, foodstuffs, sterilizing solutions, many organic chemicals, dyestuffs and wide variety of inorganic chemicals.

SSBV-Series compact breather vents are furnished with standard male pipe thread connections, they are often used on single acting stainless steel cylinders or valves to prevent dirt and foreign particles from entering port open to the atmosphere. Other common uses can also be found on vacuum relief or pressure equalization for gearboxes, crank cases, storage tanks or other vessels whenever pressure equalization is required.

Unit should be mounted in a protective position free from excessive vibration. Use wrench on hex head to tighten unit to the device. All units contain 70-micron filter element.

## Symbol

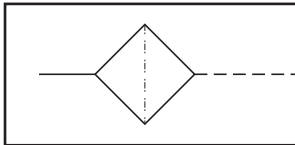

## HOW TO ORDER

**SSBV**

Stainless Steel  
Breather Vent

Connection (NPTM)

18=1/8", 28=1/4"  
38=3/8", 48=1/2"  
68=3/4", 88=1"

## FLOW CHARACTERISTICS - S.S. BREATHER VENT

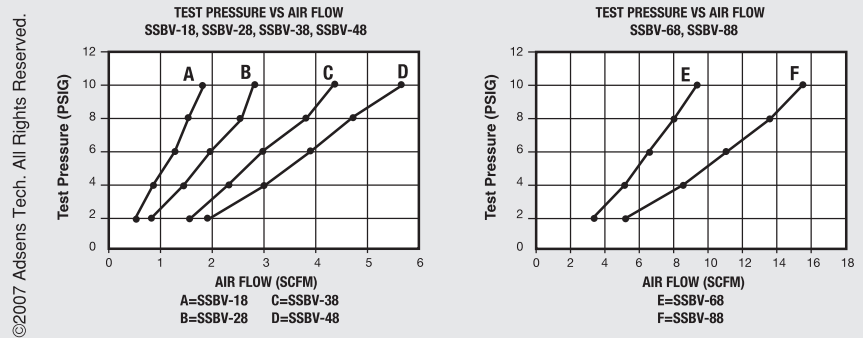

\* All tests are performed by Consolidated Laboratories, Inc.

## SPECIFICATIONS

ITEM	MODEL	SSBV-18	SSBV-28	SSBV-38	SSBV-48	SSBV-68	SSBV-88
CONNECTION	NPTM	1/8"	1/4"	3/8"	1/2"	3/4"	1"
OVERALL LENGTH	IN.	19/32"	49/64"	29/32"	1-1/32"	1-11/64"	1-1/4"
HEX	IN.	1/2"	5/8"	3/4"	15/16"	1-1/8"	1-1/2"
MATERIAL	BODY	303 GRADE STAINLESS STEEL					
	ELEMENT	316 GRADE STAINLESS STEEL (70 um)					
MAX OPERATING PRESSURE		150 PSI (10.55 kg/cm <sup>2</sup> )					
OPERATING TEMPERATURE		35°F TO 392°F (1.6°C to 200°C)					
WEIGHT (APPROX.)	OZ.	0.27	0.54	0.81	1.36	2.11	3.31
UNIT PACK	EA.	5	5	2	2	1	1

## SOUND CHARACTERISTICS - STAINLESS STEEL EXHAUST MUFFLER

BACK PRESSURE (PSIG)	SSBV-18		SSBV-28		SSBV-38		SSBV-48		SSBV-68		SSBV-88	
	FLOW (SCFM)	db	FLOW (SCFM)	db	FLOW (SCFM)	db	FLOW (SCFM)	db	FLOW (SCFM)	db	FLOW (SCFM)	db
2	0.6	60.0	0.9	60.0	1.5	60.0	1.9	62.0	3.3	60.0	5.0	60.0
4	1.0	60.0	1.5	60.0	2.4	60.5	3.0	62.5	5.0	61.5	8.5	61.0
6	1.2	60.0	2.0	60.0	3.0	61.0	3.9	64.0	6.6	62.0	11.0	61.5
8	1.5	60.0	2.4	60.5	3.7	61.5	4.8	64.5	7.9	63.5	13.5	62.0
10	1.8	60.0	2.7	60.5	4.4	62.5	5.7	65.0	9.3	65.0	15.5	62.0

\* All tests are performed by Consolidated Laboratories, Inc.

# STAINLESS STEEL SPEED CONTROL MUFFLER

## SSSCM-SERIES



SSSCM-Series stainless steel muffler with speed control provides infinite variation of control of air flow at an acceptable sound level on the exhaust ports of air valves or single acting cylinder with complete safety. They are constructed with 300-Series stainless steel materials, therefore they are resistant to atmospheric corrosion, foodstuffs, sterilizing solutions, many organic chemicals, dyestuffs and a wide variety of inorganic chemicals.

An external adjustment screw accurately varies orifice opening from closed to full flow as required. The final position can then be locked in place by the lock nut. The surrounding sleeve of stainless steel element reduces exhaust air noise. And it is protected by the integral stainless steel shroud/cage.

Unit should be mounted in a protective position free from excessive vibration. Use wrench on hex head to tighten unit to the device. All units contain 70 micron filter element.

Symbol

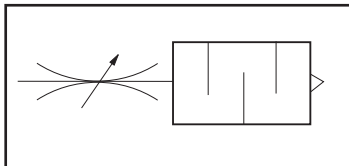

**HOW TO ORDER**

**SSSCM** —

Stainless Steel Connection (NPTM)

Speed Control Muffler 18=1/8", 28=1/4"  
38=3/8", 48=1/2"  
68=3/4", 88=1"

### SPECIFICATIONS

ITEM	MODEL	SSSCM-18	SSSCM-28	SSSCM-38	SSSCM-48	SSSCM-68	SSSCM-88
CONNECTION	NPTM	1/8"	1/4"	3/8"	1/2"	3/4"	1"
OVERALL LENGTH	IN.	1-17/32"	1-59/64"	2-1/16"	2-25/64"	2-27/32"	3-1/16"
HEX	IN.	1/2"	9/16"	11/16"	7/8"	1-1/16"	1-3/8"
MATERIAL	BODY	303 GRADE STAINLESS STEEL					
	ELEMENT	316 GRADE STAINLESS STEEL (70 um)					
MAX OPERATING PRESSURE		300 PSI (21.1 kg/cm <sup>2</sup> )					
OPERATING TEMPERATURE		35° F TO 392° F (1.6° C to 200° C)					
WEIGHT (APPROX.)	OZ.	0.63	1.03	1.63	2.91	4.85	7.81
UNIT PACK	EA.	5	5	2	2	1	1

### FLOW CHARACTERISTICS VS ADJUSTMENT - STAINLESS STEEL SPEED CONTROL MUFFLER

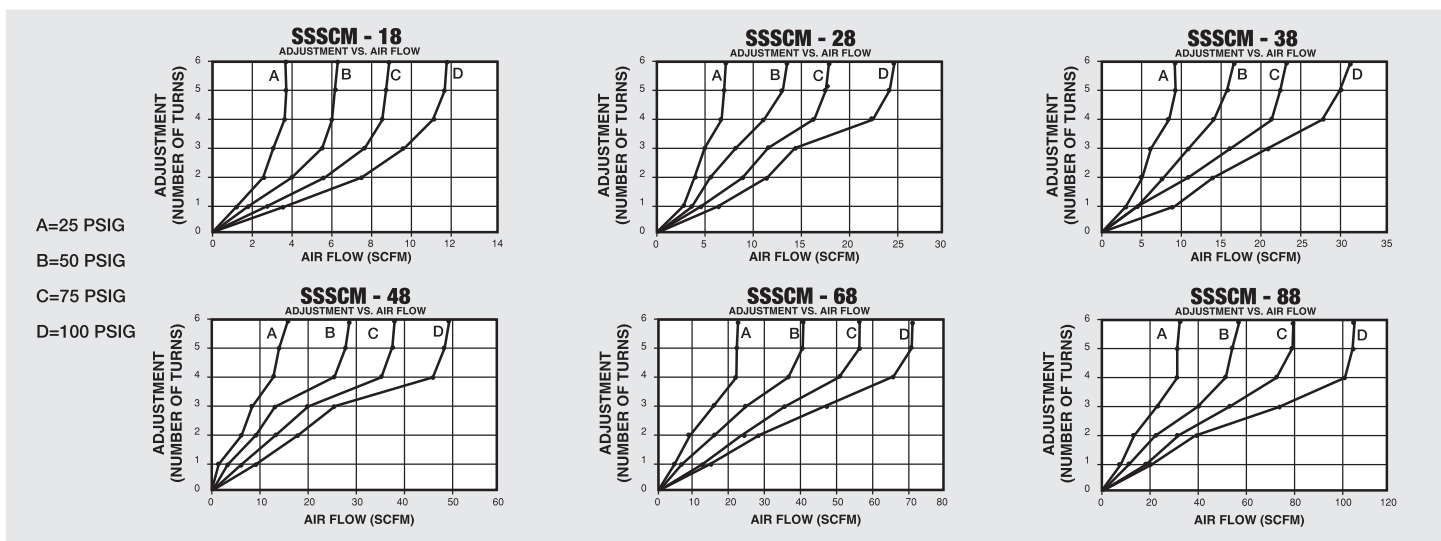

©2007 Adsens Tech. All Rights Reserved.

# SCREEN BREATHER VENT

**SBN-SERIES**



SBN-Series breather vents combine low profile and high air flow into a reality, suitable for many applications, particularly where space is limited. Special screen filter is formed by stainless steel wire, offers very high mechanical resistance, guaranteeing long life even under high pressure. Nickel-plated iron fitting offers additional corrosion resistance.

Supplied with standard male pipe threads, they can be installed with little protrusion as a flat integral part of the equipment. Unit should be mounted in a protective position from excessive vibration. Use wrench on hex head to tighten unit to the device. Stainless steel wire screen can be easily cleaned by reversing the flow of the filtered matter.

**Symbol**

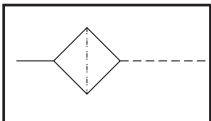

**HOW TO ORDER**

**SBN**

Screen Breather  
Vent



Connection (NPTM)

18=1/8", 28=1/4"  
38=3/8", 48=1/2"  
68=3/4", 88=1"

**SPECIFICATIONS**

ITEM	MODEL	SBN-18	SBN-28	SBN-38	SBN-48	SBN-68	SBN-88
CONNECTION	NPTM	1/8"	1/4"	3/8"	1/2"	3/4"	1"
OVERALL LENGTH	IN.	11/16"	7/8"	1"	1-3/16"	1-1/2"	1-11/16"
HEX	IN.	1/2"	5/8"	3/4"	1"	1-1/8"	1-1/2"
NOISE LEVEL @60 PSI	dB	70	69	85	85	86	88
NOISE LEVEL @115 PSI	dB	74	72	88	90	90	92
MATERIAL	BODY	NICKEL-PLATED IRON (Ni-Fe)					
	ELEMENT	STAINLESS STEEL WIRE SCREEN (10 ~ 150 um)					
MAX OPERATING PRESSURE		300 PSI (21.1 kg/cm <sup>2</sup> )					
OPERATING TEMPERATURE		35°F TO 300°F (1.6°C to 149°C)					
WEIGHT (APPROX.)	OZ.	0.30	0.56	0.90	1.45	2.70	4.43
UNIT PACK	EA.	10	10	10	10	5	1

**FLOW CHARACTERISTICS**

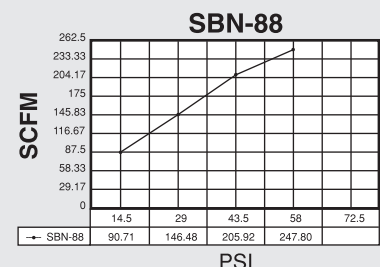
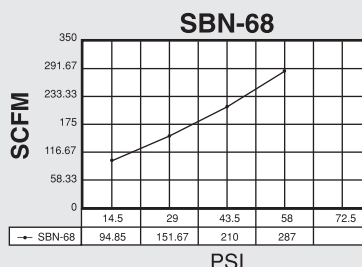
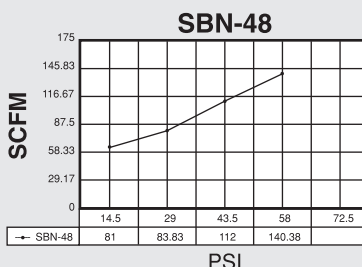
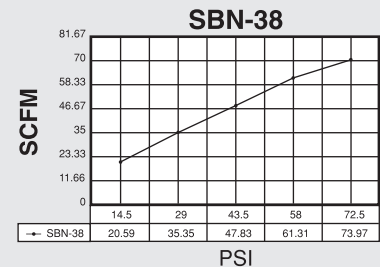
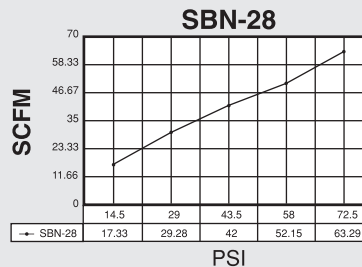
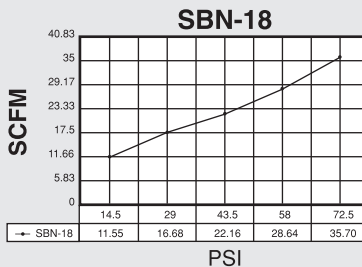

©2007 Adsens Tech. All Rights Reserved.

\* All tests are performed by Consolidated Laboratories, Inc.

# REPAIRABLE AIR/OIL IN-LINE FILTER

RIF-SERIES



RIF-Series in-line filters are designed to protect small air tools, such as grinders, impact wrenches, nut runners and screwdrivers. It will extend tool life and reduces downtime by preventing foreign particles from entering the air tool, therefore eliminating expensive tool repair.

Its compact and lightweight anodized aluminum body can be easily installed directly before the air tool.

RIF-Series inline filters can also be used in low-pressure hydraulic applications. They can remove debris or contaminants, hence decrease tool wear and improve system efficiency. The 40-micron filter element insures minimum pressure drop and can be easily replaced or cleaned, and is available in 20 and 90 microns.

## Symbol

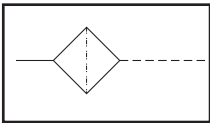

## HOW TO ORDER

**RIF** — □ □ — □ □

Repairable  
Inline Filter

### Connection (NPT)

18=1/8", 28=1/4"  
38=3/8", 48=1/2"  
68=3/4", 48F=1/2" FF  
68F=3/4" FF

### Filter Porosity

None=40 um (Standard)  
20=20 um  
90=90 um

RK — □ — □ □

Repair Kit\* 1=For RIF-18 Filter Porosity

RIF-28 20=20 um

RIF-38 40=40 um

2=For RIF-48 90=90 um

RIF-48F

RIF-68

RIF-68F

\*Each kit consist of 1 x Spring

1 x Filter Element

1 x O-Ring

## SPECIFICATIONS

ITEM	MODEL	RIF-18	RIF-28	RIF-38	RIF-48	RIF-48F	RIF-68	RIF-68F
FLUID		AIR, OIL AND WATER						
CONNECTION	NPT	1/8" F-M	1/4" F-M	3/8" F-M	1/2" F-M	1/2" F-F	3/4" F-M	3/4" F-F
OVERALL LENGTH	IN.	2-3/16"	2-3/16"	2-5/16"	3-13/16"	3-11/32"	3-7/8"	3-11/32"
HEX	IN.	3/4"	3/4"	7/8"	1-1/2"	1-1/2"	1-1/2"	1-1/2"
MATERIAL	BODY	ANODIZED ALUMINUM						
	ELEMENT	SINTERED BRONZE (40 um standard, 20 or 90 um available)						
MAX OPERATING PRESSURE		500 PSI (35.0 kg/cm <sup>2</sup> )						
OPERATING TEMPERATURE		35°F TO 200°F (1.6°C to 93.3°C)						
WEIGHT (APPROX.)		1.28	1.28	1.28	7.36	7.36	7.36	7.36
UNIT PACK	EA.	5	5	5	5	5	1	1

## FLOW CHARACTERISTICS

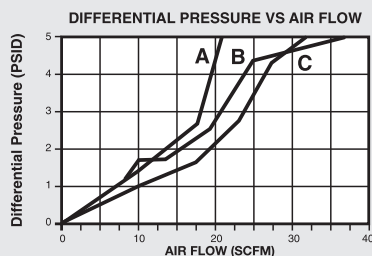

A: RIF-18  
B: RIF-28  
C: RIF-38

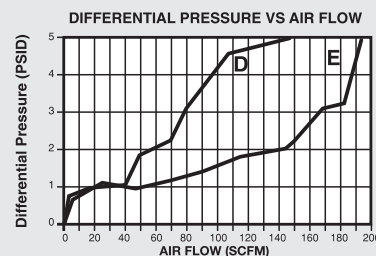

D: RIF-48, RIF-48F  
E: RIF-68, RIF-68F

Inlet Pressure = 100 psi

# NIPPLE INLINE FILTER

NIF-SERIES

NIF-Series nipple inline filter is compact, light weight and inexpensive to install at the point of use. Common usages are filtration for air, oil and water.



Unit Construction features a unique conical shaped porous sintered bronze filter element in a brass nipple fitting. Conical filter provides larger filtering surface and uninterrupted axial flow than typical disc filter.

The porous sintered bronze element is available in 40 or 90 microns; element can not be replaced and must be disposed upon end of its service life.

## Symbol

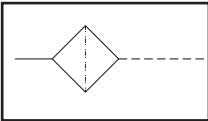

## HOW TO ORDER

**NIF**

Nipple Inline Filter

Connection (NPTM)

Filter Porosity

18=1/8", 28=1/4"

38=3/8", 48=1/2"

40 = 40 um

90 = 90 um

## SPECIFICATIONS

ITEM	MODEL	NIF-18	NIF-28	NIF-38	NIF-48
FLUID		AIR, OIL AND WATER			
CONNECTION	NPTM	1/8"	1/4"	3/8"	1/2"
OVERALL LENGTH	IN.	1-1/4"	1-1/2"	1-3/4"	2"
HEX	IN.	7/16"	9/16"	11/16"	7/8"
MATERIAL	BODY	BRASS			
	ELEMENT	SINTERED BRONZE (40 or 90 um)			
OPERATING PRESSURE		300 PSI (21.1 kg/cm <sup>2</sup> )			
OPERATING TEMPERATURE		35°F TO 300°F (1.6°C to 149°C)			
WEIGHT (APPROX.)	OZ.	0.58	0.56	2.10	3.53
UNIT PACK	EA.	5	5	5	5

# SLIDING HAND VALVE

SHV-SERIES



SHV-Series sliding hand valves are 4-way, 3-position, rotary disc, manual-operated air valves. Recommended for stationary air cylinders, arbor presses, and/or as a throttling valve for positioning air cylinder.

The 90° lever movement provides reliable switching function by the rotary disc. The rotary disc is under consistent spring pressure to provide a leak-proof seal. In center position, inlet is closed to pressure, and the outlet is closed to exhaust. Each position is positively detented and the removable handle prevents unauthorized movement.

Unit should be mounted in a protective position, free from excessive vibration. Use of filtered and lubricated air is highly recommended for maximum valve life and minimum maintenance.

Symbol

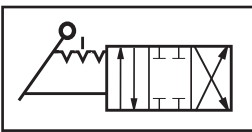

HOW TO ORDER

<b>SHV</b>	<input type="checkbox"/>	<input type="checkbox"/>	<input type="checkbox"/>	<input type="checkbox"/>
Sliding Hand Valve	Connection		Port Option	
	28 = 1/4"		None = Side Port	
	38 = 3/8"		BP = Bottom Port	
	48 = 1/2"		(Not available in 1/2")	

SPECIFICATIONS

ITEM	MODEL	SHV-28	SHV-38	SHV-48
CONNECTION	NPT	1/4"	3/8"	1/2"
FLUID		AIR		
VALVE FUNCTION		4-WAY, 3 POSITION		
OPERATION METHOD		ROTARY DISK, DIRECT-ACTING TYPE		
LEVER OPERATING ANGLE		90° (45° EACH DIRECTION)		
CV FACTOR	JIS	2.17	2.17	3.25
PRESSURE RANGE		0 TO 140 PSI (0 to 10.0 kg/cm <sup>2</sup> )		
PROOF PRESSURE		213 PSI (15.0 kg/cm <sup>2</sup> )		
OPERATING TEMPERATURE		41°F TO 140°F (5°C to 60°C)		
MATERIAL	BODY	ZINC	ALUMINUM	
	COVER		ZINC	
	ROTARY DISK		TEFLON	
WEIGHT	OZ.	21.50	21.50	20.50

DIMENSION

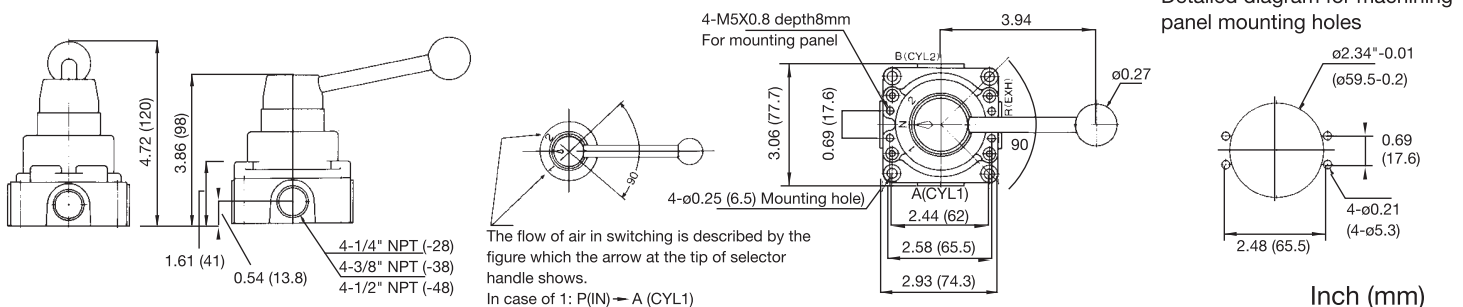

# SLEEVE VALVE

SLV-SERIES



SLV-Series sleeve valves combines high flow capability with short stroke in a small package. Unlike ball valves, sleeve valves do not require space for a handle.

SLV-Series sleeve valves features smooth opening/closing operation. Outlet is exhausted to atmosphere when the valves is closed. Unit is constructed of brass body and anodized aluminum sleeve for corrosion resistance.

**Symbol**

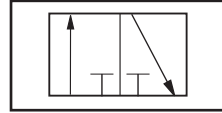

**HOW TO ORDER**

**SLV** —    
 Sleeve Valve Connection (NPT)  
 18=1/8", 28=1/4"  
 38=3/8", 48=1/2"

**SPECIFICATIONS**

ITEM	MODEL	SLV-18	SLV-28	SLV-38	SLV-48
FLUID		AIR			
CONNECTION	NPT	1/8" M-F	1/4" M-F	3/8" M-F	1/2" M-F
VALVE FUNCTION		2-POSITION, 3-WAY, VENT TO EXHAUST			
LENGTH	IN.	2-11/16"	2-7/8"	3"	3-5/8"
HEX	IN.	5/8"	11/16"	3/4"	1"
SLEEVE DIAMETER		1"	1-1/4"	1-1/4"	1-7/8"
MATERIAL	BODY	BRASS			
	SLEEVE	ANODIZED ALUMINUM			
OPERATING PRESSURE		0 TO 140 PSI (0 to 10 kg/cm <sup>2</sup> )			
OPERATING TEMPERATURE		41° TO 140°F (5° to 60°C)			

# CHECK VALVE

CHV-SERIES



CHV-Series check valves are used in fluid systems to permit free flow of air in one direction (forward flow) and prevent flow in the opposite direction (reverse flow) only, as indicated by an arrow stamped on the valve body.

**Symbol**



**HOW TO ORDER**

**CHV** —   —    
 Check Valve Connection Port Option  
 18=1/8", 28=1/4" None=Female to Female  
 38=3/8", 48=1/2" MF=Male (IN) to Female (OUT)

**SPECIFICATIONS**

ITEM	MODEL	CHV-18	CHV-28	CHV-38	CHV-48
FLUID		AIR			
CONNECTION	NPT	1/8"	1/4"	3/8"	1/2"
LENGTH	IN.	1-3/4"	2"	2"	2-1/2"
HEX	IN.	9/16"	11/16"	7/8"	1"
EFFECTIVE AREA	Cv (mm <sup>2</sup> )	1.22 (22.51)	2.00 (36.90)	2.50 (46.13)	3.80 (70.11)
MATERIAL	BODY	BRASS (NICKEL-PLATED)			
	VALVE	BRASS (NICKEL-PLATED)			
	SPRING	STAINLESS STEEL			
	O-RING	NBR			
CRACKING PRESSURE		5 PSI			
OPERATING PRESSURE		5 TO 213 PSIG (0.3 to 15.0 kg/cm <sup>2</sup> )			
OPERATING TEMPERATURE		41° TO 140° F (5° to 60°C)			



# HYDRAULIC INLINE FILTER

HIF-SERIES



The HIF-Series inline filter is used to protect high-pressure hydraulic systems up to 3,000 PSI. When installed at the pressure side of a pump, the sintered bronze filter element can trap all debris larger than 25um to prevent damage to the valves in the system.

The conical shaped sintered bronze element is positioned by a retaining spring to allow true, uninterrupted axial flow while protecting against system crashing by increasing pressure drop across the filter.

The strong yet lightweight anodized aluminum housing can be ordered with special viton O-rings for oil systems where chemical action or heat may be a problem for the standard Buna "N" O-rings. The standard 25um sintered bronze filter element can be easily cleaned or replaced. Filter elements are also available in pore sizes of 10, 40 or 90 um.

**Symbol**

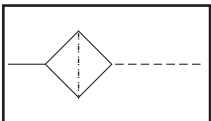

**HOW TO ORDER**

<b>HIF</b>	—	□ □	—	□ □	—	□
<b>Hydraulic Inline Filter</b>		<b>Connection</b>		<b>Element Porosity</b>		<b>O-Ring Type</b>
		28=1/4", 38=3/8"		None = 25 um		None = Buna "N"
		48=1/2", 68=3/4"		10 = 10 um		V = Viton
		SAE#6=9/16"-18		40 = 40 um		
		SAE#8=3/4"-16		90 = 90 um		

**SPECIFICATIONS**

ITEM	MODEL	HIF-28	HIF-38	HIF-48	HIF-58	HIF-SAE#6	HIF-SAE#8
CONNECTION	NPTM	1/4"	3/8"	1/2"	3/4"	9/16"-18 SAE	3/4"-16 SAE
OVERALL LENGTH	IN.	3-3/16"	3-3/16"	4-15/16"	4-15/16"	3-1/4"	3-1/4"
HEX	IN.	1-1/2"	1-1/2"	1-1/2"	1-1/2"	1-1/2"	1-1/2"
MATERIAL	BODY	ANODIZED ALUMINUM					
	ELEMENT	SINTERED BRONZE (25 um standard, 10, 40 and 90 um available)					
MAX OPERATING PRESSURE		3,000 PSI (210 kg/cm <sup>2</sup> )					
OPERATING TEMPERATURE		Standard Buna "N". 35°F to 200°F (1.7°C to 93°C), Optional Viton: 35°F to 400°F (1.7°C to 204°C)					
UNIT PACK	EA.	2	2	2	2	2	2

**FLOW CHARACTERISTICS**

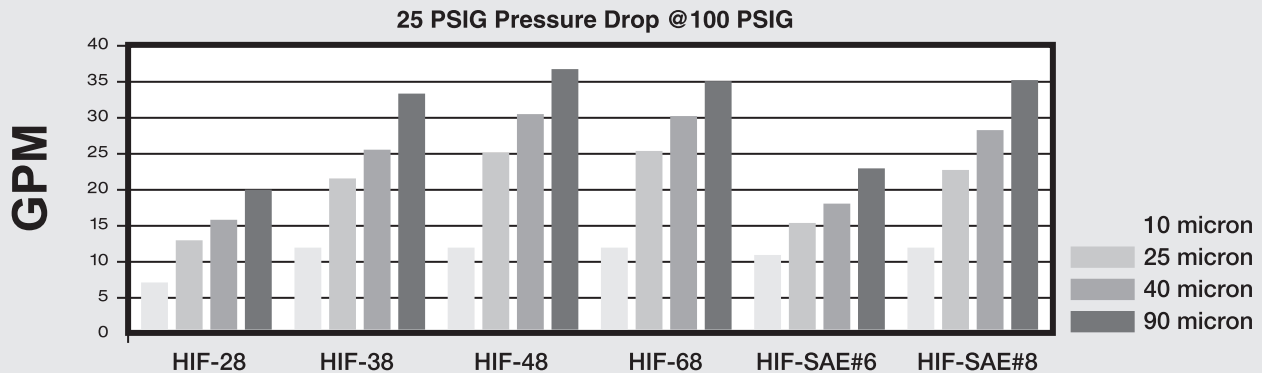

# HYDRAULIC INLINE FILTER

HIL-SERIES

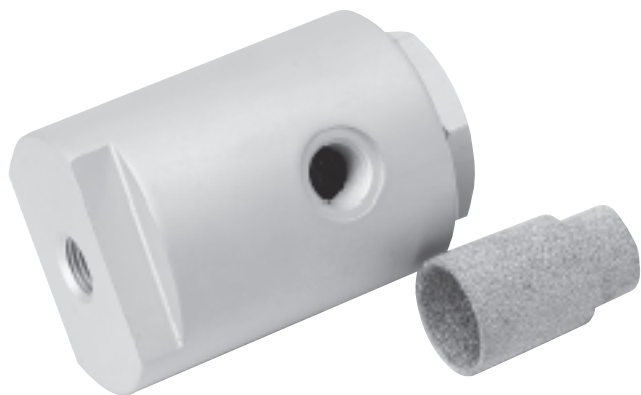

The HIL-Series inline filter is used to protect high-pressure hydraulic systems up to 5,000 PSI. When installed at the pressure side of a pump, the sintered bronze filter element can trap all debris larger than 25um to prevent damage to the valves in the system.

The design and performance is similar to the HIF-Series filters, but allows the filter element to be removed without breaking the line connections. Filter cleaning or replacement is as easy as unscrewing the filter access cap.

## Symbol

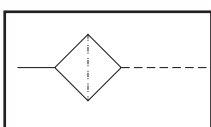

The strong yet lightweight anodized aluminum housing can be ordered with special viton O-rings for oil systems where chemical action or heat may be a problem for the standard Buna "N" O-rings. The standard 25um sintered bronze filter element can be easily cleaned or replaced. Filter elements also available in pore size of 10, 40 or 90um.

## REPLACEMENT FILTER ELEMENT KIT

FILTER TYPE	ELEMENT & SEAL KIT	UNIT PACK
HIF-28, HIF-38 HIF-SAE#6, HIF-SAE#8 All HIL-Series	REK2 (25 micron) REK2-10 (10 micron) REK2-40 (40 micron) REK2-90 (90 micron)	5
Above with Viton Seal	REK2V (25 micron) REK2V-10 (10 micron) REK2V-40 (40 micron) REK2V-90 (90 micron)	5
HIF-48 & HIF-68	REK4 (25 micron) REK4-10 (10 micron) REK4-40 (40 micron) REK4-90 (90 micron)	5
Above with Viton Seal	REK4V (25 micron) REK4V-10 (10 micron) REK4V-40 (40 micron) REK4V-90 (90 micron)	5

## HOW TO ORDER

HIL	Connection	Element Porosity	O-Ring Type
Hydraulic Inline Filter L-Type	28=1/4" 38=3/8" SAE#6=9/16"-18	None = 25um 10 = 10um 40 = 40um 90 = 90um	None = Buna"N" V = Viton

## REPLACEMENT SPRING KIT

FILTER TYPE	SPRING KIT	UNIT PACK
HIF-28, HIF-38, HIF-SAE#6, HIF-SAE#8	RSK2	5
All HIL-Series	RSK2T	5
HIF-48 and HIF-68	RSK4	5

## FLOW CHARACTERISTICS

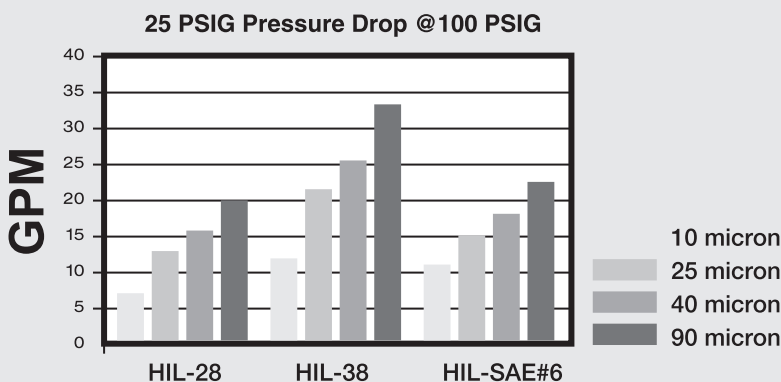

## SPECIFICATIONS

ITEM	MODEL	HIL-28	HIL-38	HIL-SAE#6
CONNECTION	NPT	1/4"	3/8"	9/16"-18 SAE
OVERALL LENGTH	IN.	3-3/16"	3-3/16"	3-3/16"
HEX	IN.	2-1/8"	2-1/8"	2-1/8"
MATERIAL	BODY	ANODIZED ALUMINUM		
	ELEMENT	SINTERED BRONZE (25 um standard, 10, 40 and 90 um available)		
MAX OPERATING PRESSURE		5,000 PSI (350 kg/cm <sup>2</sup> )		
OPERATING TEMPERATURE		Standard Buna "N": 35°F to 200°F (1.7°C to 93°C), Optional Viton: 35°F to 400°F (1.7°C to 204°C)		
UNIT PACK	EA.	2	2	2

# PRESSURE SNUBBER

PS-SERIES



PS-Series pressure snubber protects pressure instruments from sudden pressure surges and fluctuations, therefore insures accurate gauge reading. Housing is made out of solid brass with a porous bronze element to handle up to 9,000-PSI maximum pressure. Unit can also be used as a miniature inline filter.

Six different porosity elements are packaged with each unit, which allows user to tailor the snubbing capacity for different application. Replacement elements are inexpensive and easy to replace, makes cleaning of the element unneces-

## Symbol

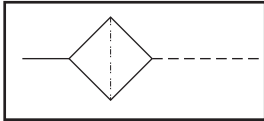

RECOMMENDED ELEMENT POROSITY RATING		
POROSITY	COLOR CODE	APPLICATION
40 um	NONE	VISCOUS FLUIDS (OVER 500 SSU)
30 um	BLACK	MED. TYPE OILS (225 TO 500 SSU)
25 um	BROWN	WATER & LT. OILS (30 TO 225 SSU)
20 um	GREEN	LOW VISCOSITY FLUIDS (UNDER 30 SSU)
10 um	RED	AIR & OTHER GASES
5 um	PURPLE	

## HOW TO ORDER

<b>PS</b>	—	□ □	—	□ □
<b>Pressure Snubber</b>		<b>Connection (NPT)</b>		<b>Filter Porosity</b>
		28=1/4" Male to 1/4" Female		05 = 5 um
		38=3/8" Male to 3/8" Female		10 = 10 um
		E=5 Replacement elements		20 = 20 um
				25 = 25 um
				30 = 30 um
				40 = 40 um

## SPECIFICATIONS

ITEM	MODEL	PS-28	PS-38
FLUID		AIR, OIL AND WATER	
CONNECTION	IN.	1/4" M-F	3/8" M-F
OVERALL LENGTH	IN.	1-3/8"	1-3/8"
HEX	IN.	3/4"	1"
MATERIAL	BODY	BRASS	
	ELEMENT	SINTERED BRONZE	
MAX OPERATING PRESSURE		9,000 PSI (633 kg/cm <sup>2</sup> )	
OPERATING TEMPERATURE		35°F TO 300°F (1.6°C to 149°C)	
WEIGHT (APPROX.)	OZ.	2.4	3.2
UNIT PACK	EA.	5	5