

Electropneumatically and pneumatically operated valves Series 3

2

2x3/2, 3/2, 5/2 and 5/3 ways C.C. C.O. C.P.
Ports G1/8 and G1/4



The G1/8 and G1/4 Series 3 solenoid valves have been designed with 3/2, 2 x 3/2, 5/2, 5/3 in two main versions which are:

- Electropneumatically actuated with mechanical spring return
- Electropneumatically actuated with external and internal air pressure supply

The Series 3 valves can be operated by Series U or G solenoids (22x22). The Series 3 is equipped with a manual override which allows a stable operation.

GENERAL DATA

Construction	spool - type (pilot operated)
Valve group	way / pos. 2x3/2 - 3/2 - 5/2 - 5/3 C.C. C.O. C.P.
Materials	aluminium body, stainless steel spool, NBR seals
Ports	G1/8 - G1/4
Installation	in any position
Operating temperature	0 + 60°C (with dry air at -20°C)
Operating pressure	see tables
Fluid	filtered air, without lubricant. If lubricated air is used, it is recommended to use ISOVG32 oil. Once applied the lubrication should never be interrupted.

CODING EXAMPLE

3	3	8	D	-	015	-	02	-	U	7	7
---	---	---	---	---	-----	---	----	---	---	---	---

3	SERIES
3	N° OF PORTS/POSITIONS: 3 = 3/2 N.C. 4 = 3/2 N.O. 5 = 5/2 6 = 5/3 C. closed 7 = 5/3 C. open 8 = 5/3 C. pressure 9 = 1x 3/2 N.C. + 1x-3/2 N.O.
8	PORTS: 8 = G1/8 4 = G1/4
D	D = double valve 2x3/2 L = for manifold assembly (only for 3/2 G1/8)
015	ACTUATION: 011 = double solenoid 015 = single solenoid, spring return 016 = single solenoid, pneumatic spring return (horizontal solenoid) E11 = double solenoid external servo-command E15 = single solenoid, external servo-command 033 = pneumatic pneumatic 035 = pneumatic spring
22	SOLENOID INTERFACE: 02 = mech. sol. 22 x 22
U	SOLENOID MATERIAL: U = PET G = PA A8 = PPS H8 = PA 6 V0 A7 = PPS
7	SOLENOID DIMENSIONS: 7 = 22 x 22 8 = 30 x 30
7	SOLENOID VOLTAGE: See page solenoids 2.2.35.01

3/2-way solenoid valve, G1/8, monostable Mod. 338..., Mod 348...

The Series 3, G1/8, 3/2-way solenoid valves, which have electropneumatic actuation and spring return, are available in the N.C. (closed) or N.O. (open) version.

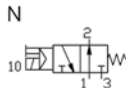
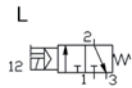
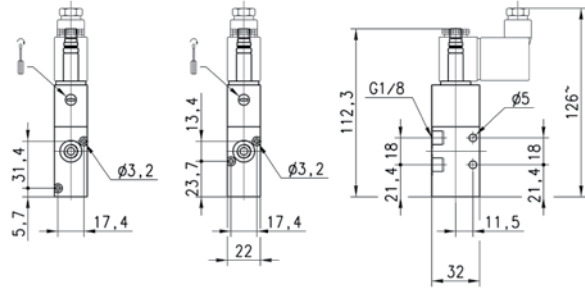

Mod.	Mounting	Function	Flow rate NI/min	Operating pressure (bar)	Symbol
338-015-02	without base	3/2 N.C.	700	2 + 10	L
338L-015-02	on manifold	3/2 N.C.	700	2 + 10	L
348-015-02	without base	3/2 N.O.	700	2 + 10	N
348L-015-02	on manifold	3/2 N.O.	700	2 + 10	N

3/2-way solenoid valve, G1/8, bistable Mod. 338...

The Series 3, G1/8, 3/2-way solenoid valves, which have electropneumatic actuation and return, assume the N.C. (closed) or N.O. (open) position depending on the last pulse received.

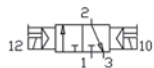
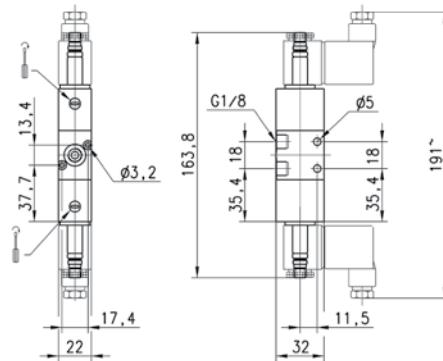

Mod.	Mounting	Function	Flow rate NI/min	Operating pressure (bar)
338-011-02	without base	3/2	700	2 + 10
338L-011-02	on manifold	3/2	700	2 + 10

2x3/2 way solenoid valve, G1/8 Mod. 338D, Mod. 348D, Mod. 398D

The Series 3, G1/8 solenoid valves are available in versions with 2 3/2 valves in the same valve.

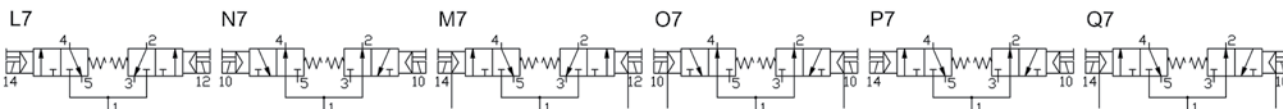
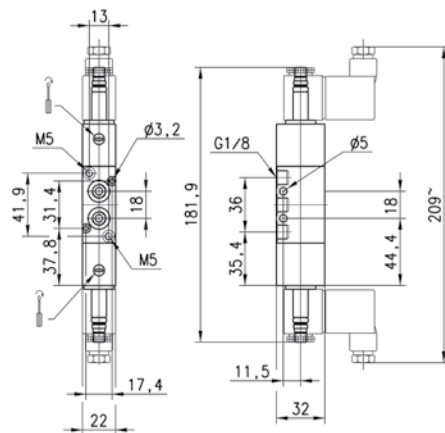

Mod.	Function	Flow rate NI/min	Operating pressure (bar)	Pilot pressure (bar)	Symbol
338D-015-02	2 X 3/2 N.C.	700	2 + 10	-	L7
348D-015-02	2 X 3/2 N.O.	700	2 + 10	-	N7
338D-E15-02	2 X 3/2 N.C.	700	0 + 10	2 + 10	M7
348D-E15-02	2 X 3/2 N.O.	700	0 + 10	2 + 10	O7
398D-015-02	1 X 3/2N.C.+1X3/2N.O.	700	2 + 10	-	P7
398D-E15-02	1 X 3/2N.C.+1X3/2N.O.	700	0 + 10	2 + 10	Q7

5/2-way solenoid valve, G1/8, monostable Mod. 358...

The Series 3, G1/8 5/2-way solenoid valves, which have electropneumatic actuation and spring return, are suitable for operating double-acting cylinders.

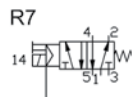
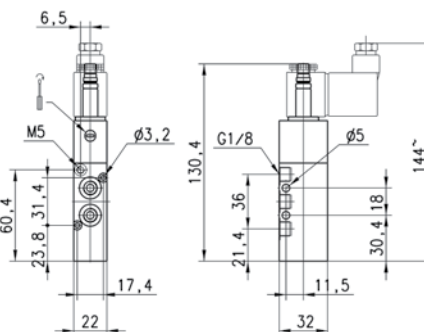

Mod.	Function	Flow rate NI/min	Operating pressure (bar)	Pilot pressure (bar)	Symbol
358-015-02	5/2	700	2 + 10	-	V
358-E15-02	5/2	700	-0,9 + 10	2 + 10	R7
358-016-02	5/2	700	2 + 10	-	Z

5/2-way solenoid valve, G1/8, bistable Mod. 358...

The Series 3, G1/8 5/2-way solenoid valves, which have electropneumatic actuation and spring return, are suitable for operating double-acting cylinders.

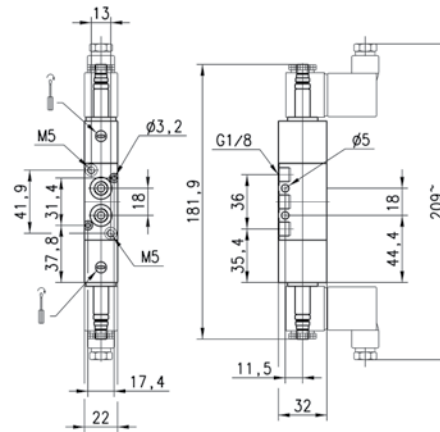

A1



S7

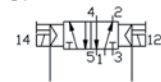

Mod.	Function	Flow rate NI/min	Operating pressure (bar)	Pilot pressure (bar)	Symbol
358-011-02	5/2	700	1,5 + 10	-	A1
358-E11-02	5/2	700	-0,9 + 10	1,5 + 10	S7

5/3-way solenoid valve, G1/8, Mod. 368... Mod. 378... Mod. 388...

C.C. = Centres closed C.O. = Centres open C.P. = Pressure centres

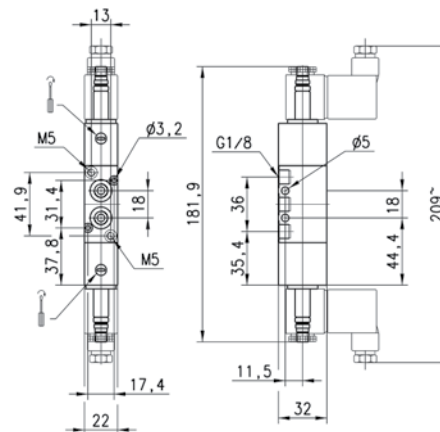

B1

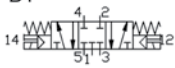

G7

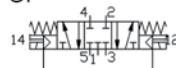

C1



H7



D1



I7



Mod.	Function	Flow rate NI/min	Operating pressure (bar)	Pilot pressure (bar)	Symbol
368-011-02	5/3 C.C.	700	2 + 10	-	B1
368-E11-02	5/3 C.C.	700	-0,9 + 10	2 + 10	G7
378-011-02	5/3 C.O.	700	2-10	-	C1
378-E11-02	5/3 C.O.	700	-0,9 + 10	2 + 10	H7
388-011-02	5/3 C.P.	700	2 + 10	-	D1
388-E11-02	5/3 C.P.	700	-0,9 + 10	2 + 10	I7

3/2-way solenoid valve, G1/4, monostable Mod. 334... Mod 344...

The Series 3, G1/4, 3/2-way solenoid valves, which have electropneumatic actuation and spring return, are available in the N.C. (closed) or N.O.(open) version.

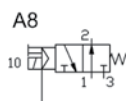
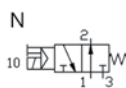
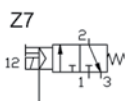
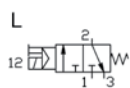
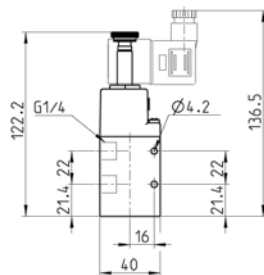
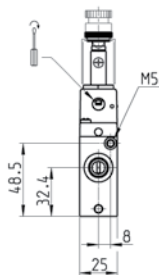

Mod.	Mounting	Function	Flow rate NI/min	Operating pressure (bar)	Pilot pressure (bar)	Symbol
334-015-02	without base	3/2 N.C.	1300	2,5 ÷ 10	-	L
334-E15-02	without base	3/2 N.C.	1300	-0,9 ÷ 10	2,5 ÷ 10	Z7
344-015-02	without base	3/2 N.O.	1300	2,5 ÷ 10	-	N
344-E15-02	without base	3/2 N.O.	1300	-0,9 ÷ 10	2,5 ÷ 10	A8

Solenoid valve 3/2 way G1/4, bistable - Mod. 334...

The Series 3, G1/4 3/2 way solenoid valves, which have electropneumatic actuation and return assume the N.C. (closed) or N.O. (open) position depending on their last pulse received.

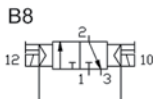
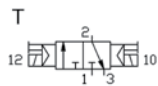
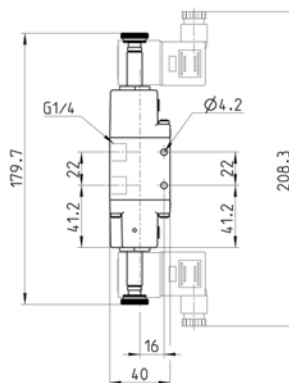
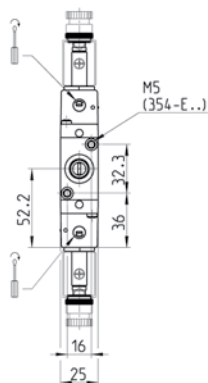

Mod.	Mounting	Function	Flow rate NI/min	Operating pressure (bar)	Pilot pressure (bar)	Symbol
334-011-02	without base	3/2	1300	2,5 ÷ 10	-	T
334-E11-02	without base	3/2	1300	-0,9 ÷ 10	2,5 ÷ 10	B8

2x3/2 way solenoid valve, G1/4 Mod. 334D Mod. 344D Mod. 394D

The Series 3, G1/4 solenoid valves are available in versions with 2 3/2 valves in the same valve.

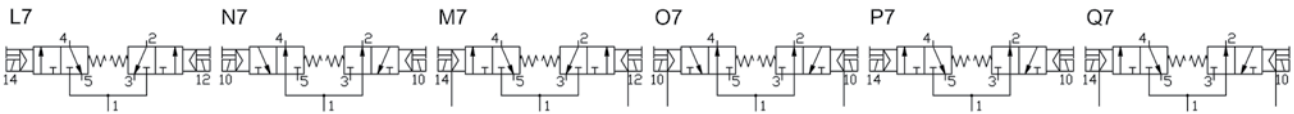
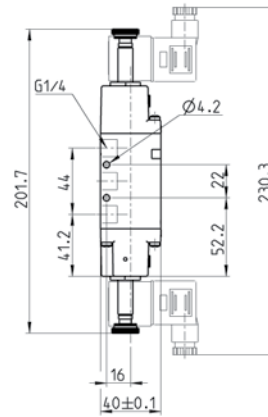
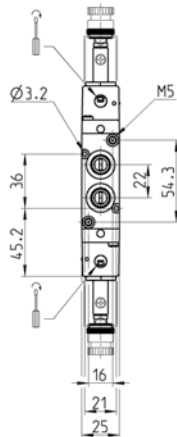

Mod.	Function	Flow rate NI/min	Operating pressure (bar)	Pilot pressure (bar)	Symbol
334D-015-02	2 X 3/2 N.C.	1200	2,5 ÷ 10	-	L7
344D-015-02	2 X 3/2 N.O.	1050	2,5 ÷ 10	-	N7
334D-E15-02	2 X 3/2 N.C.	1200	-0,9 ÷ 10	2,5 ÷ 10	M7
344D-E15-02	2 X 3/2 N.O.	1050	-0,9 ÷ 10	2,5 ÷ 10	O7
394D-015-02	1X3/2 N.C. +1X3/2 N.O.	1050	2 ÷ 10	-	P7
394D-E15-02	1X3/2 N.C. +1X3/2 N.O.	1050	-0,9 ÷ 10	2,5 ÷ 10	Q7

5/2-way solenoid valve, G1/4, monostable Mod. 354...

The Series 3, G1/4 5/2-way solenoid valves, which have electropneumatic actuation and spring return, are suitable for operating double-acting cylinders.

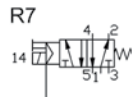
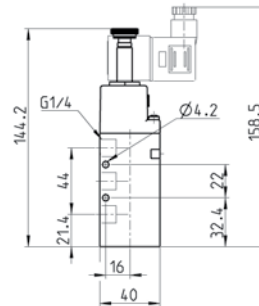
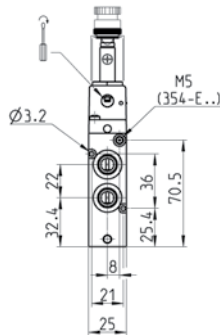

Mod.	Function	Flow rate NI/min	Operating pressure (bar)	Pilot pressure (bar)	Symbol
354-015-02	5/2	1300	2,5 ÷ 10	-	V
354-E15-02	5/2	1300	-0,9 ÷ 10	2,5 ÷ 10	R7

5/2-way solenoid valve, G1/4, bistable Mod. 354...

The Series 3, G1/4 5/2-way solenoid valves, which have electropneumatic actuation and spring return, are suitable for operating double-acting cylinders.

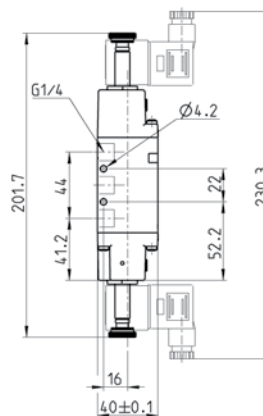
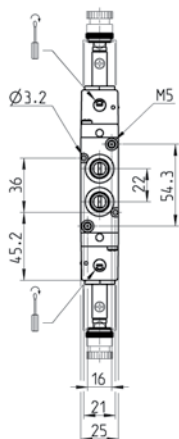

A1

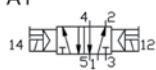

S7

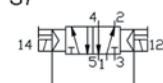

Mod.	Function	Flow rate NI/min	Operating pressure (bar)	Pilot pressure (bar)	Symbol
354-011-02	5/2	1300	2,5 + 10	-	A1
354-E11-02	5/2	1300	-0,9 + 10	2,5 + 10	S7

5/3-way solenoid valve, G1/4, Mod. 364... Mod. 374... Mod. 384...

C.C. = Centres closed C.O. = Centres open C.P. = Pressure centres

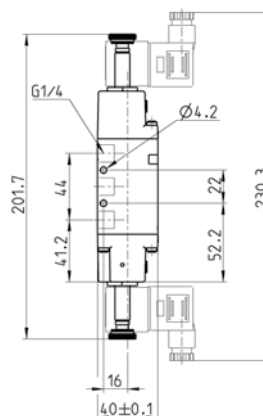
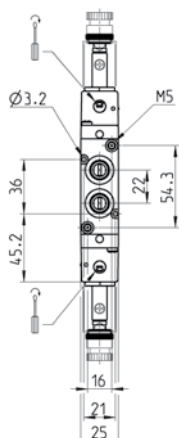

B1

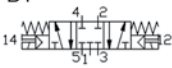

G7

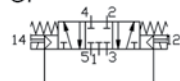

C1



H7

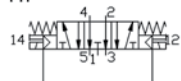

D1



I7

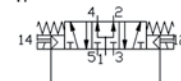

Mod.	Function	Flow rate NI/min	Operating pressure (bar)	Pilot pressure (bar)	Symbol
364-011-02	5/3 C.C.	1200	2,5 + 10	-	B1
364-E11-02	5/3 C.C.	1200	-0,9 + 10	2,5 + 10	G7
374-011-02	5/3 C.O.	1200	2,5 + 10	-	C1
374-E11-02	5/3 C.O.	1200	-0,9 + 10	2,5 + 10	H7
384-011-02	5/3 C.P.	1200	2,5 + 10	-	D1
384-E11-02	5/3 C.P.	1200	-0,9 + 10	2,5 + 10	I7

3/2 way valve, G1/8 or G1/4, monostable

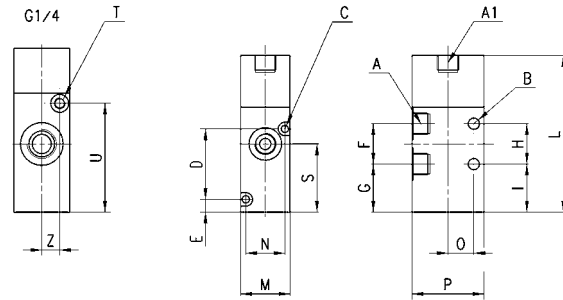
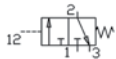

DIMENSIONS

Mod.	Mounting	Function	Flow rate NI/min	min. pil P.	A	A1	B	C	D	E	F	G	H	I	L	M	N	O	P	S	T	U	Z
338-035	without base	3/2 N.C.	700	3 bar	G1/8	G1/8	5	3,2	-	5,7	18	21,4	18	21,4	69,8	22	-	11,5	32	30,4	-	-	-
338L-035	on manifold	3/2 N.C.	700	3 bar	G1/8	G1/8	-	3,2	31,4	5,7	18	21,4	-	21,4	69,8	22	17,4	11,5	32	30,4	-	-	-
334-035	without base	3/2 N.C.	1300	3 bar	G1/4	-	4,1	-	-	-	22	21,4	22	21,4	73	25	-	16	40	32,4	M5	48,5	8

3/2 way valve, G1/8 or G1/4, bistable

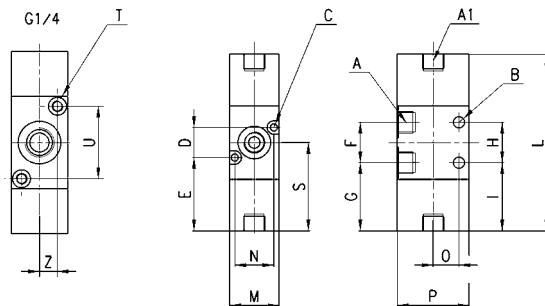
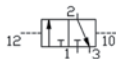

DIMENSIONS

Mod.	Mounting	Function	Flow rate NI/min	min. pil P.	A	A1	B	C	D	E	F	G	H	I	L	M	N	O	P	S	T	U	Z
338-033	without base	3/2 N.C.	700	2,5 bar	G1/8	G1/8	5	-	-	-	18	30,4	18	30,4	78,8	22	-	11,5	32	41,7	-	-	-
338L-033	on manifold	3/2 N.C.	700	2,5 bar	G1/8	G1/8	5	3,2	13,4	32,7	18	30,4	-	30,4	78,8	22	17,4	-	32	41,7	-	-	-
334-033	without base	3/2 N.C.	1300	2,5 bar	G1/4	-	4,1	-	-	-	22	29,7	22	29,7	81,3	25	-	16	40	40,7	M5	-	-

5/2 way valve, G1/8 or G1/4, monostable

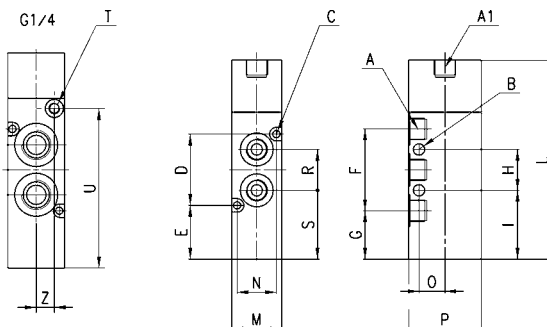

DIMENSIONS

Mod.	Mounting	Function	Flow rate NI/min	min. pil P.	A	A1	B	C	D	E	F	G	H	I	L	M	N	O	P	S	T	U	Z
358-035	without base/on manifold	3/2 N.C.	700	3 bar	G1/8	G1/8	5	3,2	31,4	23,8	36	21,4	18	30,4	87,8	22	17,4	11,5	32	30,4	-	-	-
354-035	without base/on manifold	3/2 N.C.	1300	3 bar	G1/4	-	4,1	3,2	36	25,4	44	21,4	22	30,4	95	25	21	16	40	32,4	M5	70,5	8

5/2 way valve, G1/8 or G1/4, bistable

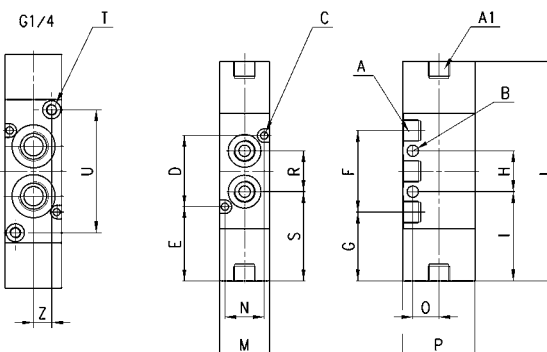
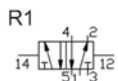

DIMENSIONS

Mod.	Mounting	Function	Flow rate NI/min	min. pil P.	A	A1	B	C	D	E	F	G	H	I	L	M	N	O	P	S	T	U	Z
358-033	without base/on manifold	5/2	700	2,5 bar	G1/8	G1/8	5	3,2	31,4	32,8	36	30,4	18	39,4	96,8	22	17,4	11,5	32	39,4	-	-	-
354-033	without base/on manifold	5/2	1300	2,5 bar	G1/4	-	4,1	3,2	36	33,7	44	29,7	22	40,7	103,3	25	21	16	40	40,7	M5	54,3	8

5/3 way valve, G1/8 or G1/4

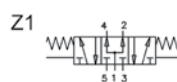
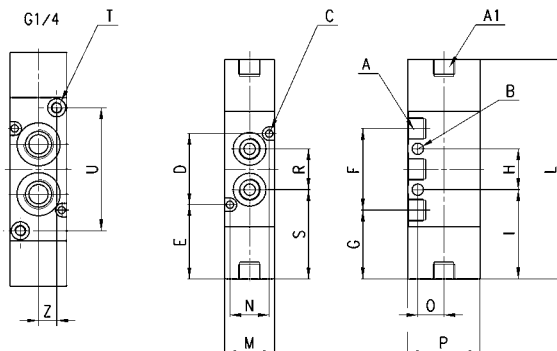

DIMENSIONS

Mod.	Mounting	Function	Flow rate NI/min	min. pil P.	A	A1	B	C	D	E	F	G	H	I	L	M	N	O	P	S	T	U	Z	Symbol
368-033	without b./on man.	5/3 C.C.	700	2,5	G1/8	G1/8	5	3,2	31,4	32,8	36	30,4	18	39,4	96,8	22	17,4	11,5	32	39,4	-	-	-	U1
364-033	without b./on man.	5/3 C.C.	1200	2,5	G1/4	-	4,1	3,2	36	33,7	44	29,7	22	40,7	103,3	25	21	16	40	40,7	M5	54,3	8	U1
378-033	without b./on man.	5/3 C.O.	700	2,5	G1/8	G1/8	5	3,2	31,4	32,8	36	30,4	18	39,4	96,8	22	17,4	11,5	32	39,4	-	-	-	V1
374-033	without b./on man.	5/3 C.O.	1050	2,5	G1/4	-	4,1	3,2	36	33,7	44	29,7	22	40,7	103,3	25	21	16	40	40,7	M5	54,3	8	V1
388-033	without b./on man.	5/3 C.P.	700	2,5	G1/8	G1/8	5	3,2	31,4	32,8	36	30,4	18	39,4	96,8	22	17,4	11,5	32	39,4	-	-	-	Z1
384-033	without b./on man.	5/3 C.P.	1050	2,5	G1/4	-	4,1	3,2	36	33,7	44	29,7	22	40,7	103,3	25	21	16	40	40,7	M5	54,3	8	Z1

2x 3/2 way valve, G1/8 or G1/4

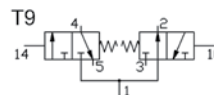
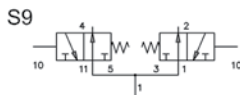
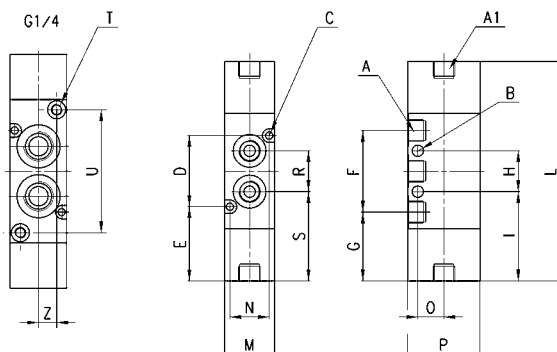

DIMENSIONS

Mod.	Mounting	Function	Flow rate NI/min	min. pil P.	A	A1	B	C	D	E	F	G	H	I	L	M	N	O	P	S	T	U	Z	Symb.
338D-035	no base/on man.	2x3/2 N.C.	700	2,5	G1/8	G1/8	5	3,2	31,4	32,8	36	30,4	18	39,4	96,8	22	17,4	11,5	32	39,4	-	-	-	R9
334D-035	no base/on man.	2x3/2 N.C.	1050	2,5	G1/4	-	4,1	3,2	36	33,7	44	29,7	22	40,7	103,3	25	21	16	40	40,7	M5	54,3	8	R9
348D-035	no base/on man.	2x3/2 N.O.	700	2,5	G1/8	G1/8	5	3,2	31,4	32,8	36	30,4	18	39,4	96,8	22	17,4	11,5	32	39,4	-	-	-	S9
344D-035	no base/on man.	2x3/2 N.O.	1050	2,5	G1/4	-	4,1	3,2	36	33,7	44	29,7	22	40,7	103,3	25	21	16	40	40,7	M5	54,3	8	S9
398D-035	no base/on man.	2x3/2 N.C.-N.O.	700	2,5	G1/8	G1/8	5	3,2	31,4	32,8	36	30,4	18	39,4	96,8	22	17,4	11,5	32	39,4	-	-	-	T9
394D-035	no base/on man.	2x3/2 N.C.-N.O.	1050	2,5	G1/4	-	4,1	3,2	36	33,7	44	29,7	22	40,7	103,3	25	21	16	40	40,7	M5	54,3	8	T9

Manifold bars with separate exhausts (low version)

out of production

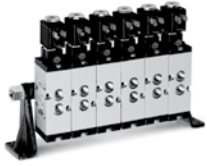

The following is supplied:

- 2x feet
- 1x manifold
- 1x inlet fitting
- 1x plug
- 4x washers

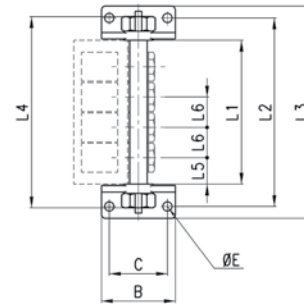
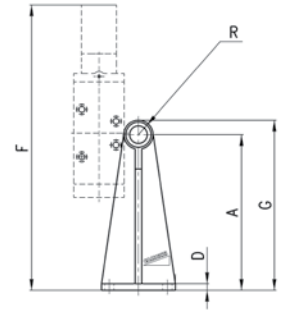

DIMENSIONS

Mod.	N° of valves	A	B	C	D	ØE	F	G	R	L1	L2	L3	L4	L5	L6	Suitable for
CNV-318-2	2	73	56	44	5	7	178	83	G1/4	63	97	115	99	20	23	3 - G1/8
CNV-318-3	3	73	56	44	5	7	178	83	G1/4	86	120	138	119	20	23	3 - G1/8
CNV-318-4	4	73	56	44	5	7	178	83	G1/4	109	143	161	142	20	23	3 - G1/8
CNV-318-5	5	73	56	44	5	7	178	83	G1/4	132	166	184	165	20	23	3 - G1/8
CNV-318-6	6	73	56	44	5	7	178	83	G1/4	155	189	207	188	20	23	3 - G1/8

The fixing screws of the valves mod. 1635-01 and the washers mod.2661 must be ordered separately.

Manifold bars with separate exhausts (high version)

out of production



The following is supplied:

- 2x feet
- 1x manifold
- 1x inlet fitting
- 1x plug
- 4x washers

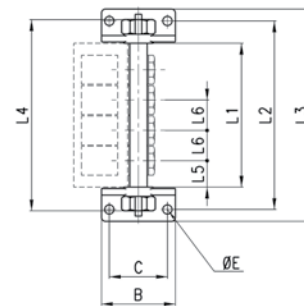
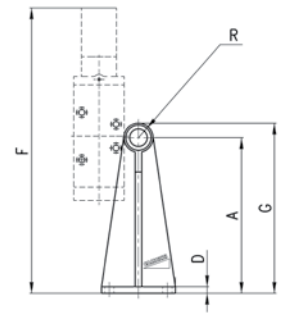

DIMENSIONS

Mod.	N° of valves	A	B	C	D	ØE	F	G	R	L1	L2	L3	L4	L5	L6	Suitable for
CNV-328-2	2	118	56	44	5	7	223	128	G1/4	63	97	115	99	20	23	3 - G1/8
CNV-328-3	3	118	56	44	5	7	223	128	G1/4	86	120	138	119	20	23	3 - G1/8
CNV-328-4	4	118	56	44	5	7	223	128	G1/4	109	143	161	142	20	23	3 - G1/8
CNV-328-5	5	118	56	44	5	7	223	128	G1/4	132	166	184	165	20	23	3 - G1/8
CNV-328-6	6	118	56	44	5	7	223	128	G1/4	155	189	207	188	20	23	3 - G1/8

The fixing screws of the valves mod. 1635-01 and the washers mod.2661 must be ordered separately.

Basic Module with three positions - Mod. CNVL-...

The following is supplied:

- 3x O-Rings
- 2x fixing nuts
- 2x junction plugs
- 9x interface seals
- 6x fixing screws

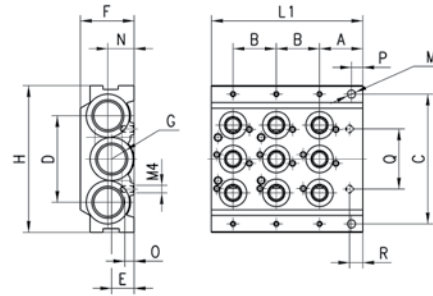

DIMENSIONS

Mod.	A	B	C	D	E	F	H	L1	M	N	O	P	Q	R	G
CNVL-3H3	23	23	69,5	46	12	29	78	80,5	4,3	14	5	6	32	7	3/8
CNVL-4H3	26	26	88	60	14	29	98	91	4,3	-	5	5	38	7	1/2

Basic module with 2 positions - Mod. CNVL-...

The following is supplied:

- 3x O-Rings
- 2x fixing nuts
- 2x junction plugs
- 6x interface seals
- 4x fixing screws

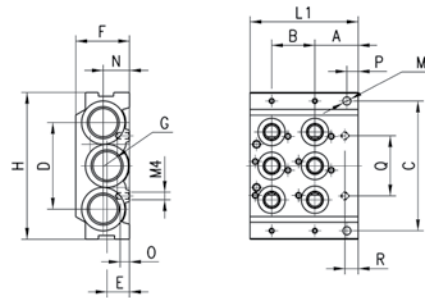

DIMENSIONS

Mod.	A	B	C	D	E	F	H	L1	M	N	O	P	Q	R	G
CNVL-3H2	23	23	69,5	46	12	29	78	57,5	4,3	14	5	6	32	7	3/8
CNVL-4H2	26	26	88	60	14	29	98	65	4,3	-	5	5	38	7	1/2

Intermediate module with 3 positions - Mod. CNVL-...

The following is supplied:

- 3x O-Rings
- 2x fixing nuts
- 2x junction plugs
- 9x interface seals
- 6x fixing screws

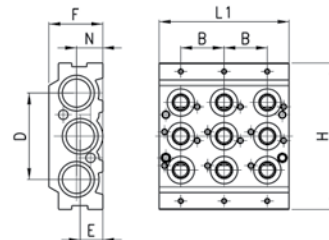

DIMENSIONS

Mod.	B	D	E	F	H	L1	N
CNVL-3I3	23	46	12	29	78	69	14
CNVL-4I3	26	60	14	29	98	65	-

Intermediate module with 2 positions - Mod. CNVL-...



The following is supplied:

- 3x O-Rings
- 2x fixing nuts
- 2x junction plugs
- 6x interface seals
- 4x fixing seals

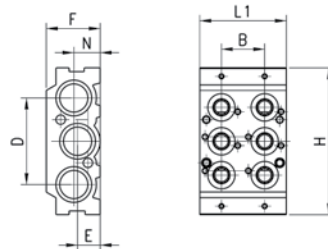

DIMENSIONS							
Mod.	B	D	E	F	H	L1	N
CNVL-3I2	23	46	12	29	78	46	14
CNVL-4I2	26	60	14	29	98	52	-

Intermediate module with 1 position - Mod. CNVL-...



The following is supplied:

- 3x O-Rings
- 2x fixing nuts
- 2x junction plugs
- 3x interface seals
- 2x fixing seals

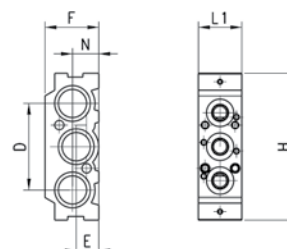

DIMENSIONS						
Mod.	D	E	F	H	L1	N
CNVL-3I1	46	12	29	78	23	14
CNVL-4I1	60	14	29	98	26	-

Terminal module Mod. CNVL-3H



The following is supplied:

- 2x fixing nuts

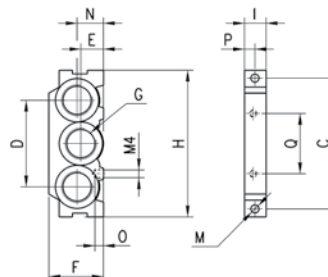

DIMENSIONS												
Mod.	C	D	E	F	H	I	M	N	O	P	Q	G
CNVL-3H	69,5	46	12	29	78	11,5	4,3	14	5	6	32	3/8
CNVL-4H	88	60	14	29	98	13	4,3	-	5	8	29	1/2

Interface module manifold between G1/4 and G1/8 (Series 3)



The following is supplied:

- 1x interface seal
- 2x screws
- 2x pins
- 2x plugs
- 6x O-Rings

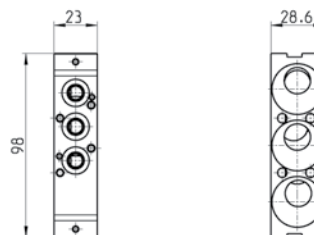

Mod.
CNVL-4H-3H

Intermediate plate for additional inlet and exhaust pressure

The following is supplied:
 3x O-Rings
 2x fixing screws

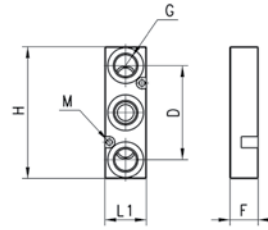

DIMENSIONS								
Mod.	Series	G	H	M	F	L1	D	F
CNVL-3P	3 1/8	G1/4	70	3,2	29	22	50	15
CNVL-4P	3 1/4	G1/4	73	3,2	29	25	50	20

Diaphragm

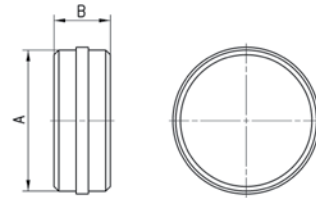

DIMENSIONS				
Mod.	Series	A	B	Supply
CNVL-3H-TP	3 G1/8	15,6	6	Channels diaphragm 1; 3; 5
CNVL-4H-TP	3 G1/4	23,8	8	Channels diaphragm 1; 3; 5

Blanking plug for TCNVL manifolds

The following is supplied:
 1x blanking plug
 1x O-Ring

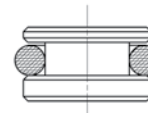

DIMENSIONS	
Mod.	Series
TCNVL/3	Serie 3 G1/8

Blanking plate for CNVL manifolds, Mod. CNVL...

The item is used to blank one or more stations on a manifold baseMod.CNVL...,
 The following is supplied:
 2x fixing screws
 3x O-Rings

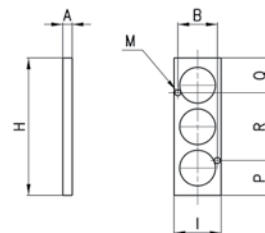
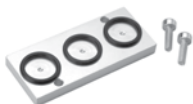

DIMENSIONS									
Mod.	Series	A	B	H	I	M	P	Q	R
CNVL-1	Series 3 G1/8	5	17,4	52	22	3,2	10,3	10,3	31,4
CNVL-4	Series 3 G1/4	5	21	73	25	3,2	18,5	18,5	36